

# Narrow Bandpass Filters



Schneider-Kreuznach magnetron sputtered industrial narrow bandpass filters feature steep slopes for sophisticated applications that require a sharp transition between high transmission and deep blocking at stable cut-on and cut-off wavelengths. The layers are applied by means of magnetron sputtering, a special coating process.

Schneider-Kreuznach narrow bandpass filters are RoHS conform. Custom sizes are available on request



Key features	Applications
<ul style="list-style-type: none"> <li>• Average transmittance 90%</li> <li>• Steep slopes</li> <li>• Wavelength tolerance +/- 3nm</li> <li>• Deep blocking / High optical density</li> </ul>	<ul style="list-style-type: none"> <li>• Laser applications</li> <li>• 3D Measurement and Metrology</li> <li>• Food and beverage inspection</li> <li>• Ophthalmology</li> <li>• Microscopy</li> </ul>

Standard Products		available on request	
Name	Description	Name	Description
NBP 635-20 HT	Narrow Bandpass 625 - 645 nm	NBP 405-15 HT	Narrow Bandpass 398 - 413 nm
NBP 660-10 HT	Narrow Bandpass 655 - 665 nm	NBP 457-20 HT	Narrow Bandpass 447 - 467 nm
		NBP 488-20 HT	Narrow Bandpass 478 - 498 nm
		NBP 532-20 HT	Narrow Bandpass 522 - 542 nm
		NBP 810-45 HT	Narrow Bandpass 788 - 833 nm
		NBP 830-20 HT	Narrow Bandpass 820 - 840 nm

# Narrow Bandpass 405-15 HT - on req.

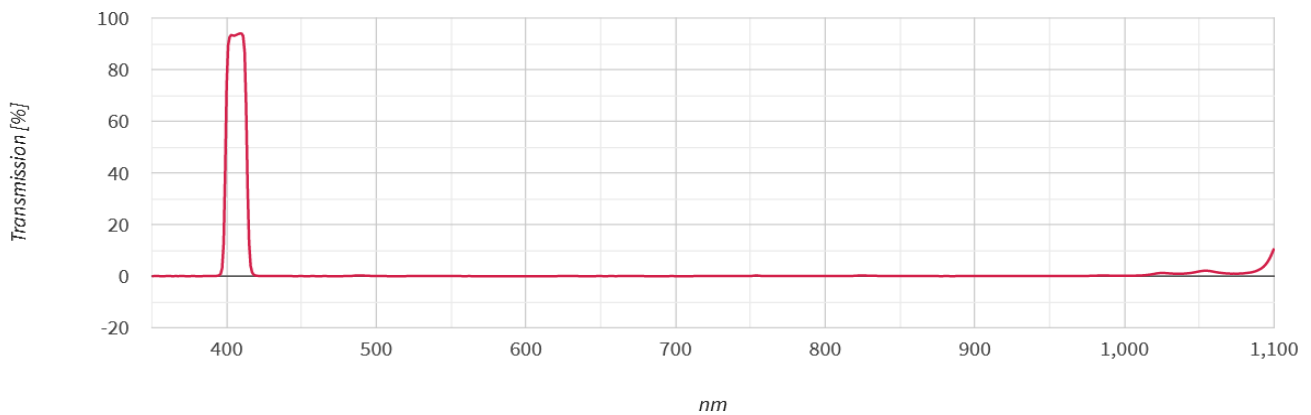

Technical specifications	according to ISO 10110
Angle of incident	0° +/- 8°
Central Wavelength (CWL)	405 +/- 3nm
Full Width at Half Maximum (FWHM)	14 +/- 1nm
Transmittance	403 - 407 nm: T <sub>abs</sub> > 80%
Blocking	< 395 nm: T <sub>abs</sub> < 0.5%
	425 - 1000 nm: T <sub>abs</sub> < 0.5%
Parallelism	1'
Wavefront distortion	∅ >18 - 30 mm: 13/ 1(0.25)
	∅ >30 - 50 mm: 13/ 1(0.30)

# Narrow Bandpass 457-20 HT - on req.

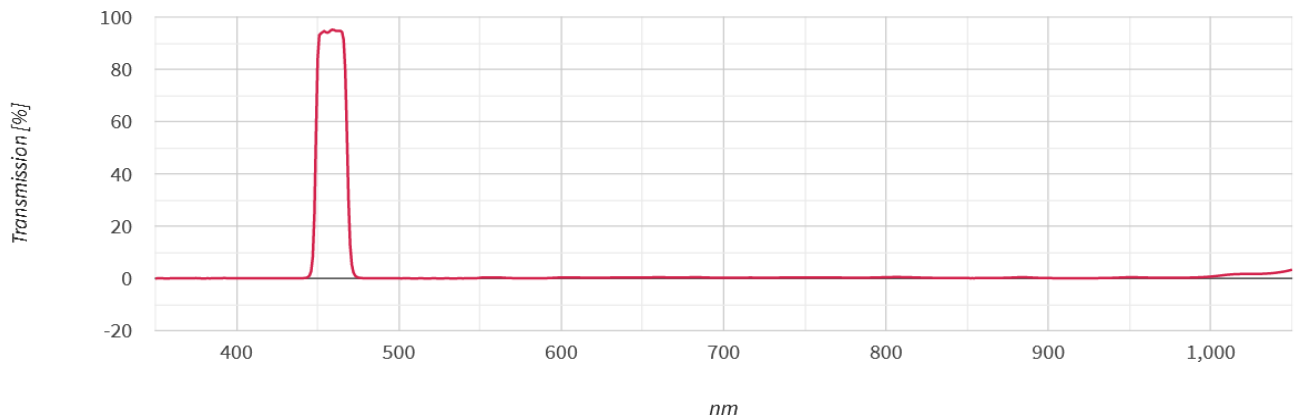

Technical specifications	according to ISO 10110
Angle of incident	0° +/- 8°
Central Wavelength (CWL)	457 +/- 3nm
Full Width at Half Maximum (FWHM)	19 +/- 1nm
Transmittance	445 - 459 nm: T <sub>abs</sub> > 90%
Blocking	< 430 nm: T <sub>abs</sub> < 0.5%
	485 - 990 nm: T <sub>abs</sub> < 0.5%
Parallelism	1'
Wavefront distortion	Ø >18 - 30 mm: 13/ 1(0.25)
	Ø >30 - 50 mm: 13/ 1(0.30)

# Narrow Bandpass 488-20 HT - on req.

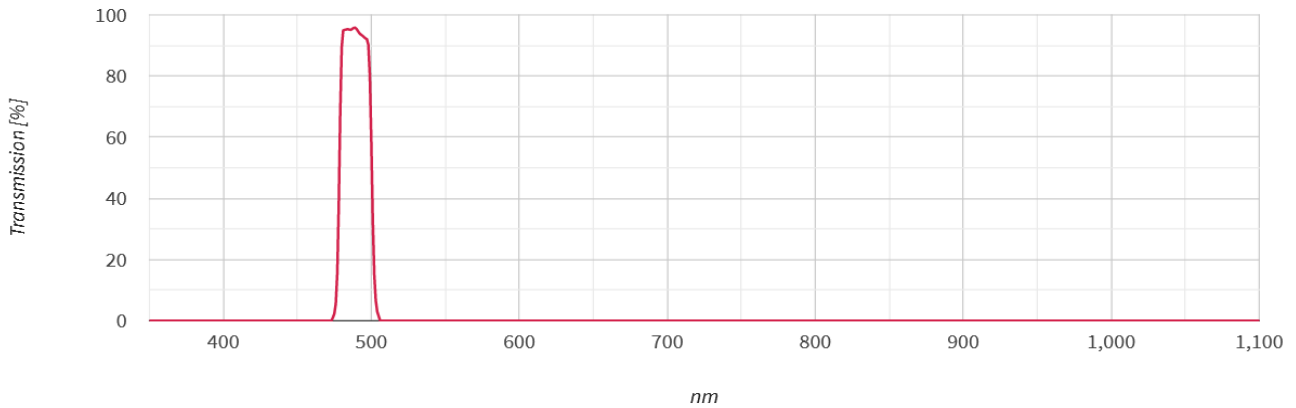

Technical specifications	according to ISO 10110
Angle of incident	0° +/- 8°
Central Wavelength (CWL)	488 +/- 3nm
Full Width at Half Maximum (FWHM)	22 +/- 1nm
Transmittance	486 - 490 nm: $T_{abs} > 90\%$
Blocking	< 460 nm: $T_{abs} < 0.5\%$
	515 - 990 nm: $T_{abs} < 0.5\%$
Parallelism	1'
Wavefront distortion	Ø >18 - 30 mm: 13/ 1(0.25)
	Ø >30 - 50 mm: 13/ 1(0.30)

# Narrow Bandpass 532-20 HT - on req.

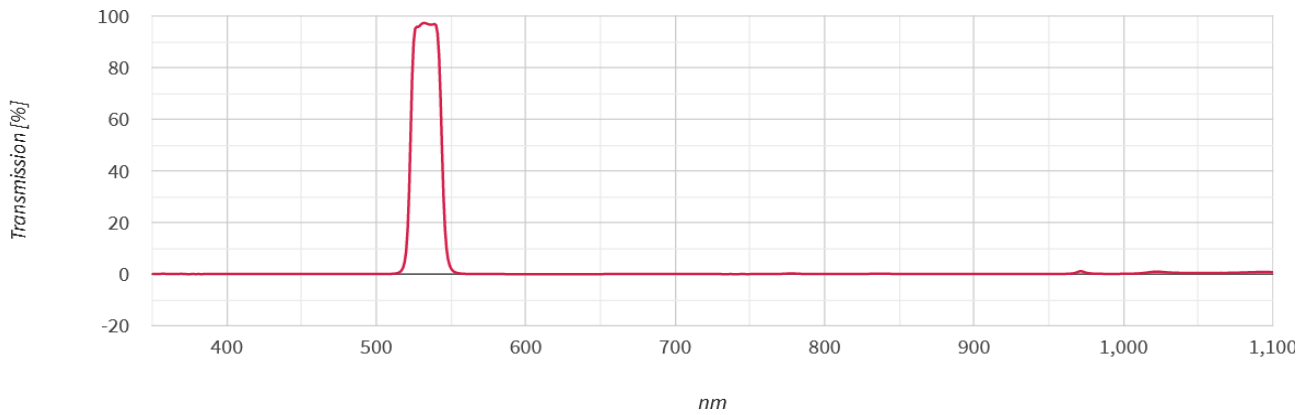

Technical specifications	according to ISO 10110
Angle of incident	0° +/- 8°
Central Wavelength (CWL)	532 +/- 3nm
Full Width at Half Maximum (FWHM)	21 +/- 1nm
Transmittance	530 - 534 nm: $T_{abs} > 90\%$
Blocking	< 505 nm: $T_{abs} < 0.5\%$
	560 - 960 nm: $T_{abs} < 0.5\%$
	960 - 1100 nm: $T_{abs} < 1.0\%$
Parallelism	1'
Wavefront distortion	Ø >18 - 30 mm: 13/ 1(0.25)
	Ø >30 - 50 mm: 13/ 1(0.30)

# Narrow Bandpass 635-20 HT

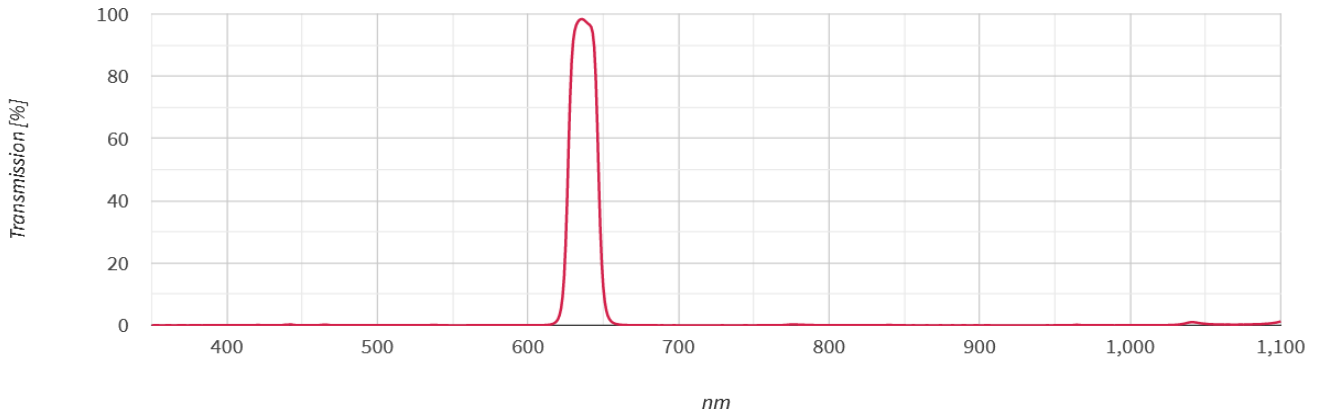

Technical specifications	according to ISO 10110
Angle of incident	0° +/- 8°
Central Wavelength (CWL)	635 +/- 3nm
Full Width at Half Maximum (FWHM)	20 +/- 1nm
Transmittance	633 - 637 nm: T <sub>abs</sub> > 90%
	< 610 nm: T <sub>abs</sub> < 0.5%
Blocking	660 - 1000 nm: T <sub>abs</sub> < 0.5%
	1000 - 1100 nm: T <sub>abs</sub> < 2.0%
Parallelism	1'
Wavefront distortion	Ø >18 - 30 mm: 13/ 1(0.25)
	Ø >30 - 50 mm: 13/ 1(0.30)
Glass Thickness	1.0 +/- 0.08mm
	2.0 +/- 0.08mm

Mounted Filter			Unmounted Filterglass		
IF NBP 635-20 HT <i>Mount Thickness</i>			IFG NPB 635-20 HT <i>Diameter thickness</i>		
Mount	Thickness	ID	Diameter	Thickness	ID
CMT	2mm	1088568	22.0 mm	2mm	1085478
CMT	1mm	<i>ID to be defined</i>	22.0 mm	1mm	<i>ID to be defined</i>
SH 25.5	2mm	1092367	23.0 mm	2mm	<i>ID to be defined</i>
SH 25.5	1mm	<i>On request only</i>	23.0 mm	1mm	<i>On request only</i>
SH 27.0	2mm	1090822	24.0 mm	2mm	1085479
SH 27.0	1mm	<i>On request only</i>	24.0 mm	1mm	<i>On request only</i>
SN1 30.5	2mm	1085800	29.0 mm	2mm	1085481
SN1 30.5	1mm	<i>On request only</i>	29.0 mm	1mm	<i>On request only</i>
SH 34.0	2mm	<i>ID to be defined</i>	31.0 mm	2mm	<i>ID to be defined</i>
SH 34.0	1mm	<i>On request only</i>	31.0 mm	1mm	<i>On request only</i>
SH 35.5	2mm	<i>ID to be defined</i>	33.0 mm	2mm	<i>ID to be defined</i>
SH 35.5	1mm	<i>On request only</i>	33.0 mm	1mm	<i>On request only</i>
SH 37.0	2mm	<i>ID to be defined</i>	34.0 mm	2mm	1085482
SH 37.0	1mm	<i>On request only</i>	34.0 mm	1mm	<i>ID to be defined</i>
SH 39.0	2mm	1088548	36.0 mm	2mm	<i>ID to be defined</i>
SH 40.5	2mm	<i>ID to be defined</i>	38.0 mm	2mm	<i>ID to be defined</i>
SH 43.0	2mm	<i>ID to be defined</i>	40.0 mm	2mm	<i>ID to be defined</i>
SH 46.0	2mm	<i>ID to be defined</i>	43.0 mm	2mm	1088523
SH 49.0	2mm	<i>ID to be defined</i>	46.0 mm	2mm	1085483

Custom sizes are available on request.

Example: IF NBP 635-20 HT SH 25.5 2

Custom sizes are available on request.

Example: IFG NPB 635-20 HT 23.0 2

# Narrow Bandpass 660-10 HT

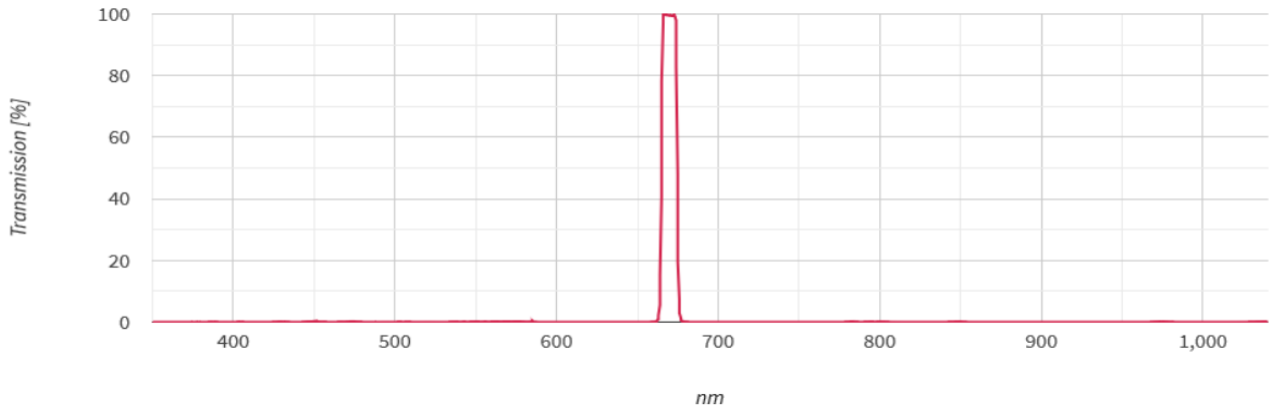

Technical specifications	according to ISO 10110
Angle of incident	0° +/- 5°
Central Wavelength (CWL)	660 +/- 3nm
Full Width at Half Maximum (FWHM)	10 +/- 1nm
Transmittance	658 - 662 nm: T <sub>abs</sub> > 80%
Blocking	< 645 nm: T <sub>abs</sub> < 0.5%
	680 - 1000 nm: T <sub>abs</sub> < 0.5%
Parallelism	1'
Wavefront distortion	Ø >18 - 30 mm: 13/ 1(0.25)
	Ø >30 - 50 mm: 13/ 1(0.30)
Glass Thickness	1.0 +/- 0.08mm
	2.0 +/- 0.08mm

Mounted Filter			Unmounted Filterglass		
IF NBP 660-10 HT <i>Mount Thickness</i>			IFG NPB 660-10 HT <i>Diameter thickness</i>		
Mount	Thickness	ID	Diameter	Thickness	ID
CMT	2mm	1089657	22.0 mm	2mm	1085863
CMT	1mm	<i>ID to be defined</i>	22.0 mm	1mm	<i>ID to be defined</i>
SH 25.5	2mm	1090046	23.0 mm	2mm	<i>ID to be defined</i>
SH 25.5	1mm	<i>On request only</i>	23.0 mm	1mm	<i>On request only</i>
SH 27.0	2mm	1090143	24.0 mm	2mm	1085864
SH 27.0	1mm	<i>On request only</i>	24.0 mm	1mm	<i>On request only</i>
SN1 30.5	2mm	1085801	29.0 mm	2mm	1085866
SN1 30.5	1mm	<i>On request only</i>	29.0 mm	1mm	<i>On request only</i>
SH 34.0	2mm	<i>ID to be defined</i>	31.0 mm	2mm	<i>ID to be defined</i>
SH 34.0	1mm	<i>On request only</i>	31.0 mm	1mm	<i>On request only</i>
SH 35.5	2mm	1100893	33.0 mm	2mm	<i>ID to be defined</i>
SH 35.5	1mm	<i>On request only</i>	33.0 mm	1mm	<i>On request only</i>
SH 37.0	2mm	<i>ID to be defined</i>	34.0 mm	2mm	1085856
SH 37.0	1mm	<i>On request only</i>	34.0 mm	1mm	<i>ID to be defined</i>
SH 39.0	2mm	<i>ID to be defined</i>	36.0 mm	2mm	<i>ID to be defined</i>
SH 40.5	2mm	<i>ID to be defined</i>	38.0 mm	2mm	<i>ID to be defined</i>
SH 43.0	2mm	<i>ID to be defined</i>	40.0 mm	2mm	<i>ID to be defined</i>
SH 46.0	2mm	<i>ID to be defined</i>	43.0 mm	2mm	<i>ID to be defined</i>
SH 49.0	2mm	<i>ID to be defined</i>	46.0 mm	2mm	1085867

Custom sizes are available on request.

Example: IF NBP 660-10 HT SH 25.5 2

Custom sizes are available on request.

Example: IFG NPB 660-10 HT 23.0 2

# Narrow Bandpass 810-45 HT - on req.

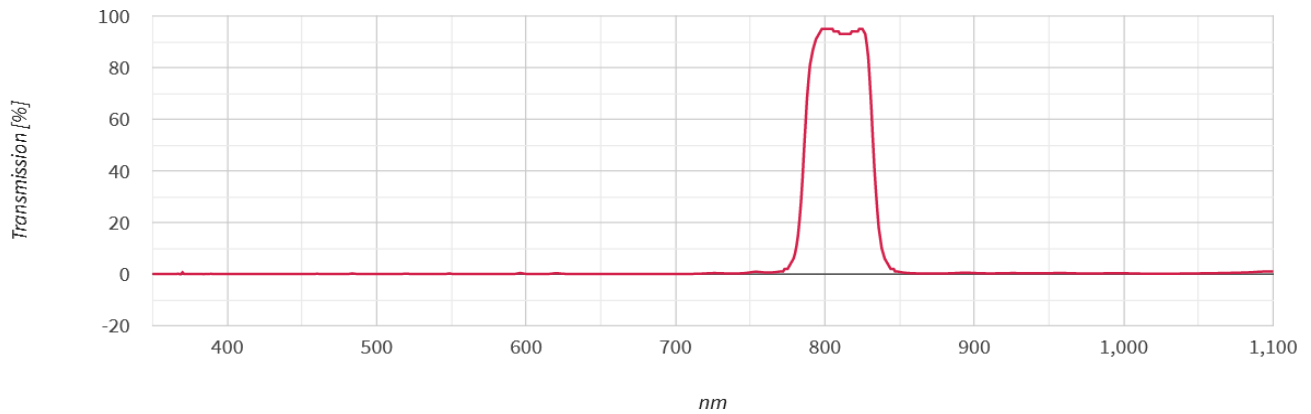

Technical specifications	according to ISO 10110
Angle of incident	0° +/- 8°
Central Wavelength (CWL)	810 +/- 4nm
Full Width at Half Maximum (FWHM)	45 +/- 2nm
Transmittance	800 - 820 nm: $T_{abs} > 90\%$
Blocking	< 750 nm: $T_{abs} < 1.0\%$
	855 - 1000 nm: $T_{abs} < 1.0\%$
Parallelism	1'
Wavefront distortion	Ø >18 - 30 mm: 13/ 1(0.25)
	Ø >30 - 50 mm: 13/ 1(0.30)



# Narrow Bandpass 830-20 HT - on req.

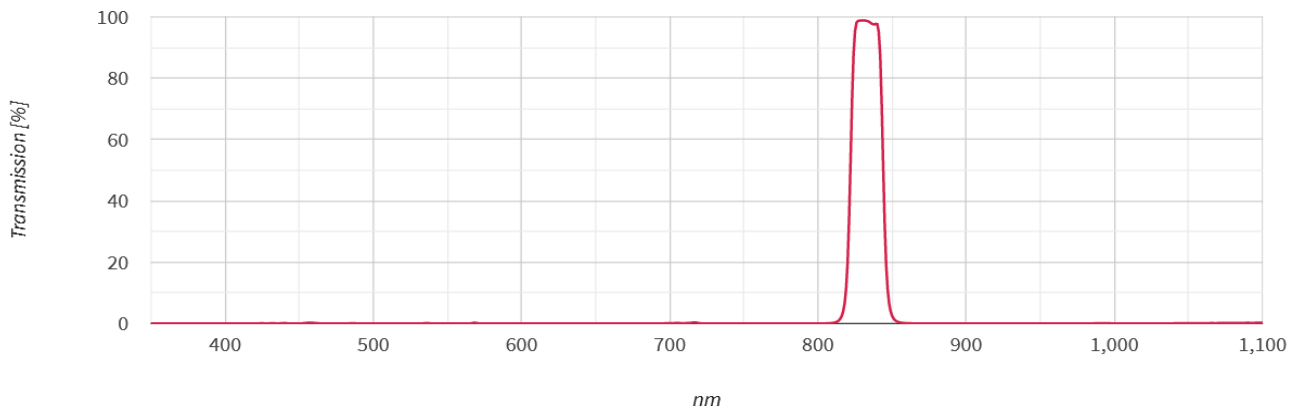

Technical specifications	according to ISO 10110
Angle of incident	0° +/- 8°
Central Wavelength (CWL)	830 +/- 4nm
Full Width at Half Maximum (FWHM)	22 +/- 1nm
Transmittance	828 - 832 nm: $T_{abs} > 90\%$
Blocking	< 805 nm: $T_{abs} < 0.5\%$
	855 - 1100 nm: $T_{abs} < 0.5\%$
Parallelism	1'
Wavefront distortion	Ø >18 - 30 mm: 13/ 1(0.25)
	Ø >30 - 50 mm: 13/ 1(0.30)

## C-Mount

Defined by 1" (25.4mm) diameter and 32 turns per inch pitch, C-Mount thread is a popular camera mount in machine vision industry. Schneider-Kreuznach offers for most filters a CMT mount option. So that filters can go in any C-Mount based mechanics in vision systems. Another popular application, CMT mounts can easily be used for, is placing a filter in front of the sensor into the camera. The extension of the back flange distance has to be considered for imaging applications.

Key features	Applications
--------------	--------------

- Fits in C-Mount cameras
- Black Anodized Brass
- To be mounted in C-Mount cameras
- Vision Systems based on C-Mount mechanics

Thread	Diameter	Clear Aperture	Thickness
1" - 32	25.4 mm	21.1 mm	3.6 mm

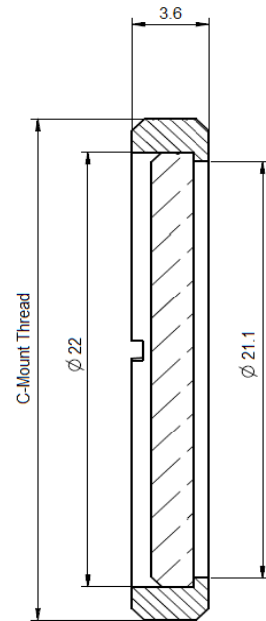

## SH-Mount

Schneider-Kreuznach offers a variety of mounts with common thread sizes to fit on most camera lens systems. SH-Mount is the standard, when high flexibility is needed. Filters are held by retainer rings. SH-Mounts are extreme robust. All SH-Mounts have a female M-thread, and can be stacked if several filters must be combined.

Key features	Applications
--------------	--------------

- Stackable
- Robust
- Black Anodized Brass
- Mounted on lenses in imaging applications
- Mounted on measurement instruments

Thread	Diameter	Clear Aperture	Thickness
M 25.5x0.5	29.5 mm	20.8mm	6.4 mm
M 27.0x0.5	31.0 mm	21.8 mm	6.4 mm
M 35.5x0.5	39.5 mm	29.8 mm	6.4 mm
M 37.0x0.75	41.0 mm	31.8 mm	6.9 mm
M 39.0x0.5	43.0 mm	33.8 mm	6.4 mm
M 40.5x0.5	44.5 mm	35.8 mm	6.4 mm
M 43.0x0.75	47.0 mm	37.8 mm	6.9 mm
M 46.0x0.75	50.0 mm	40.8 mm	6.9 mm
M 49.0x0.75	53.0 mm	43.8 mm	6.9 mm
M 52.0x0.75	56.0 mm	46.8 mm	6.9 mm
M 55.0x0.75	59.0 mm	49.8 mm	6.9 mm
M 58.0x0.75	62.0 mm	52.8 mm	6.9 mm
M 62.0x0.75	66.0 mm	56.8 mm	6.9 mm
M 67.0x0.75	71.0 mm	61.8 mm	6.9 mm

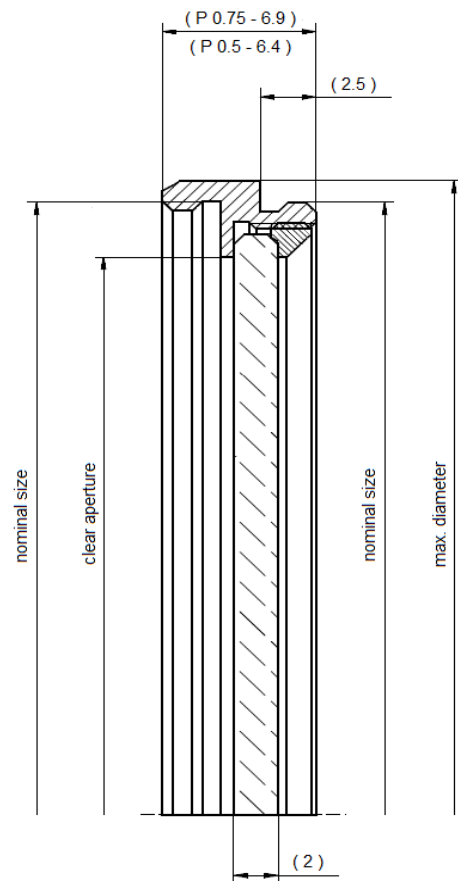

## SN1-Mount

SN1-Mount was designed for in machine vision industry popular M30.5x0.5 thread. With its high clear aperture, vignetting can be avoided, even for wide angle applications. The filter is glued into the mount, in order to secure it against vibrations when integrated into robots or production lines. It is ideal to be used in automated fabrication.

SN1-Mounts have a male and female M-thread, and can be stacked if several filters must be combined.

Key features	Applications
--------------	--------------

- |  |   |
|--|---|
| <ul style="list-style-type: none"> <li>• Maximum Clear Aperture</li> <li>• No vignetting</li> <li>• Stackable</li> <li>• Robust</li> <li>• Black Anodized Brass</li> </ul> | <ul style="list-style-type: none"> <li>• Mounted on lenses in imaging applications</li> <li>• Mounted on measurement instruments</li> </ul> |
|--|---|

Thread	Diameter	Clear Aperture	Thickness
M 30.5x0.5	32 mm	28 mm	6.5 mm

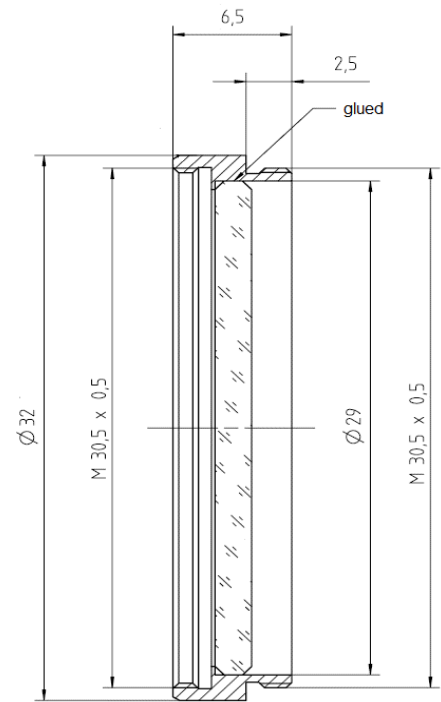

## SN2-Mount

The SN2-Mount is designed for polarizers and achieves highest possible aperture, avoiding vignetting in machine vision systems. Its unique locking mechanism fixes the correct orientation, even in typical industrial environment. The filters are glued into the mount to secure them against vibrations when integrated into robots or production lines. Ideal to be used in automated fabrication.

SN2-Mounts have a female and male M-thread, and can be stacked if several filters must be combined.

Key features	Applications
--------------	--------------

- |  |   |
|--|---|
| <ul style="list-style-type: none"> <li>• Rotatable</li> <li>• High clear Aperture</li> <li>• No vignetting</li> <li>• Stackable</li> <li>• Robust</li> <li>• Black Anodized Brass</li> </ul> | <ul style="list-style-type: none"> <li>• Mounted on lenses in imaging applications</li> <li>• Mounted on measurement instruments</li> </ul> |
|--|---|

Thread	Diameter	Clear Aperture	Thickness
M 25.5x0.5	27 mm	22.7 mm	7.4 mm
M 27.0x0.5	28.5 mm	23.7 mm	7.4 mm
M 30.5x0.5	32 mm	26.7 mm	7.4 mm
M 35.5 x0.5	37 mm	31.7 mm	7.4 mm
M 37.0x0.75	38.5 mm	32.7 mm	7.4 mm
M 40.5x0.5	42 mm	36.7 mm	7.4 mm
M 43.0x0.75	44.5 mm	37.7 mm	7.4 mm
M 46.0x0.75	47.5 mm	41.7 mm	7.4 mm
M 49.0x0.75	50.5 mm	44.7 mm	7.4 mm

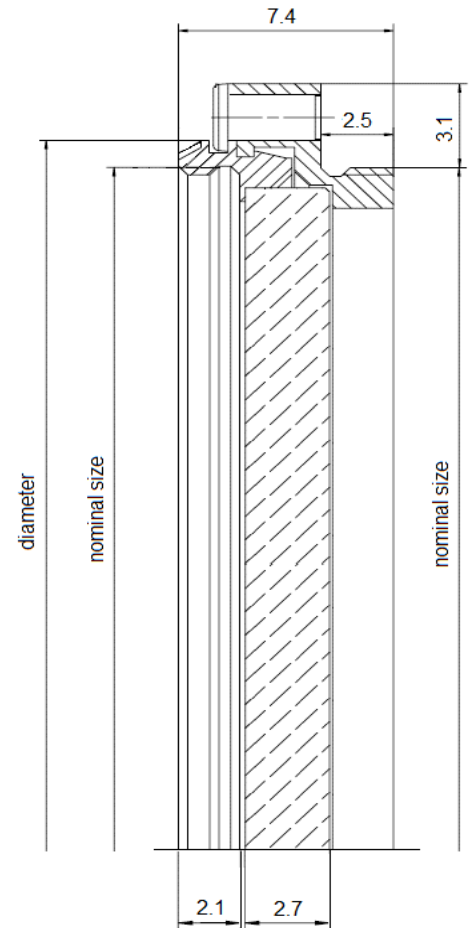

## DH-Mount

Schneider-Kreuznach offers a variety of mounts for polarizers with common thread sizes to fit on most camera lens systems. The DH-Mount is rotatable to adjust polarization axis in the required orientation. Filters are held by retainer rings. All DH-Mounts have a female and male M-thread and can be stacked if several filters must be combined.

Key features	Applications
--------------	--------------

- Rotatable
- Mounted on lenses in imaging applications
- Stackable
- Mounted on measurement instruments
- Black Anodized Brass

Thread	Diameter	Clear Aperture	Thickness
M 25.5x0.5	27 mm	20.8 mm	9.2 mm
M 27.0x0.5	28.5 mm	21.8 mm	9.2 mm
M 30.5x0.5	32 mm	25.8 mm	9.2 mm
M 35.5 x0.5	37 mm	30.8 mm	9.2 mm
M 37.0x0.75	38.5 mm	31.8 mm	9.2 mm
M 40.5x0.5	42 mm	35.8 mm	9.2 mm
M 43.0x0.75	44.5 mm	37.8 mm	9.2 mm
M 46.0x0.75	47.5 mm	40.8 mm	9.2 mm
M 49.0x0.75	50.5 mm	43.8 mm	9.2 mm
M 52.0x0.75	53.5 mm	46.8 mm	9.2 mm
M 55.0x0.75	56.5 mm	49.8 mm	9.2 mm
M 58.0x0.75	59.5 mm	52.8 mm	9.2 mm
M 62.0x0.75	63.5 mm	56.8 mm	9.2 mm
M 67.0x0.75	68.5 mm	61.8 mm	9.2 mm

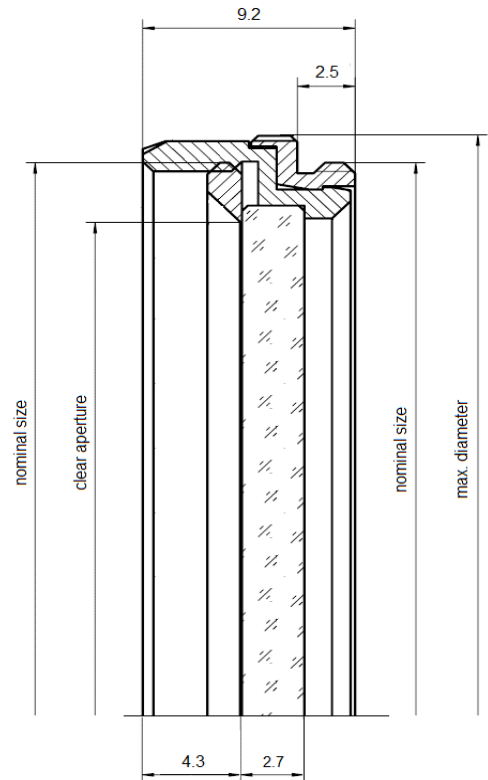

## Headquarters Europe

### Jos. Schneider Optische Werke GmbH

Ringstraße 132

55543 Bad Kreuznach

+49 671 601 205

cs@schneiderkreuznach.com

www.schneiderkreuznach.com

## Offices Worldwide

### America

+1 800 645 7239 (East Coast)

+1 800 228 1254 (West Coast)

info@schneideroptics.com

### Asia

+86 755 8832 1170

info@schneider-asiapacific.com