

Longpass 590 HT - on request



Schneider-Kreuznach magnetron sputtered industrial longpass filters impress with steep slopes and high transmission at stable cut-on wavelengths. The very flat surface makes them ideal for high end machine vision systems in factory automation. All longpass filters come with superior antireflection coating. Schneider-Kreuznach longpass filters are RoHS conform. Custom sizes are available on request.



Key features	Applications
<ul style="list-style-type: none"> • Average transmittance 95% • Steep slopes • Wavelength tolerance of interference filters +/- 1% • Ultra low reflection • Deep blocking / High optical density 	<ul style="list-style-type: none"> • Metrology • 3D Measurement • Food and beverage inspection • Automotive • Security and surveillance

Standard Products		available on request	
Name	Description	Name	Description
LP 365 E	absorption filter - UV-Cut >365 nm	LP 400 HT	Longpass > 400 nm
LP 430 HT	Longpass > 430 nm	LP 460 HT	Longpass > 460 nm
LP 600 E	absorption filter - Light Red	LP 495 HT	Longpass > 495 nm
LP 625 E	absorption filter - Red	LP 515 HT	Longpass > 515 nm
LP 695	absorption filter - Dark Red	LP 530 HT	Longpass > 530 nm
LP 765 HT	Longpass > 765 nm	LP 565 HT	Longpass > 565 nm
LP 775	absorption filter - NIR Pass	LP 590 HT	Longpass > 590 nm
LP 820 HT	Longpass > 820 nm	LP 610 HT	Longpass > 610 nm
LP 825	absorption filter - Black Red	LP 630 HT	Longpass > 630 nm
LP 900 HT	Longpass > 900 nm	LP 695 HT	Longpass > 695 nm
		LP 725 HT	Longpass > 725 nm
		LP 780 HT	Longpass > 780 nm
		LP 850 HT	Longpass > 850 nm

Longpass 590 HT - on request

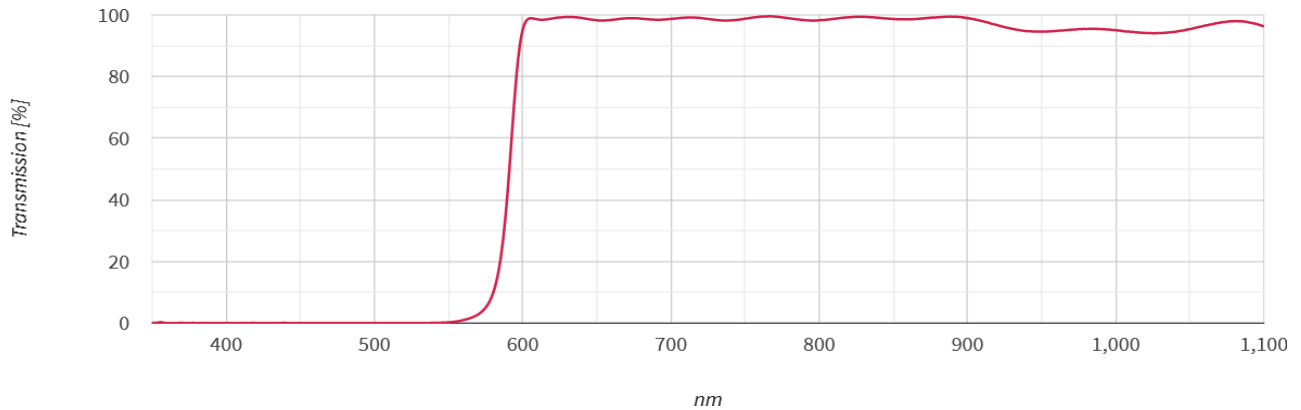

Technical specifications	according to ISO 10110
Angle of incident	0° +/- 8°
Cut-on wavelength	590 +/- 6 nm
Transmittance	610 - 900 nm: T _{abs} > 90% 610 - 900 nm: T _{ave} > 95%
Blocking	< 535 nm: T _{abs} < 0.5%
Wavefront distortion	∅ >18 - 30 mm: 13/ 1(0.25) ∅ >30 - 50 mm: 13/ 1(0.30)
Parallelism	1'
Glass thickness tolerance	+/- 0.08mm

C-Mount

Defined by 1" (25.4mm) diameter and 32 turns per inch pitch, the C-Mount thread is a popular camera mount in machine vision industry. Schneider-Kreuznach offers a CMT mount option for most filters. So filters fit in any C-Mount based mechanics, including the C-Mount thread of a camera. The extension of the back flange distance has to be considered for imaging applications.

Key features	Applications
--------------	--------------

- | | |
|---|---|
| <ul style="list-style-type: none"> • Fits in C-Mount cameras • Robust • Black anodized brass | <ul style="list-style-type: none"> • Mounted in C-Mount camera threads • In vision systems based on C-Mount mechanics |
|---|---|

Thread	Diameter	Clear Aperture	Thickness
1" - 32	25.4 mm	21.1 mm	3.6 mm

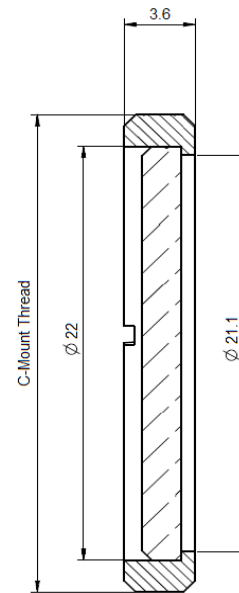

SH-Mount

SH-Mount is the standard thread mount when high flexibility and stability is required. The filter glass is held in place by a retainer ring. SH-Mounts are extremely robust, have a female and male M-thread and can be stacked if several filters must be combined.

Key features	Applications
--------------	--------------

- | | |
|---|---|
| <ul style="list-style-type: none"> • Stackable • Robust • Black anodized brass | <ul style="list-style-type: none"> • Mounted on lenses • Mounted on measurement instruments |
|---|---|

Thread	Diameter	Clear Aperture	Thickness
M 25.5x0.5	29.5 mm	20.8mm	6.4 mm
M 27.0x0.5	31.0 mm	21.8 mm	6.4 mm
M 35.5x0.5	39.5 mm	29.8 mm	6.4 mm
M 37.0x0.75	41.0 mm	31.8 mm	6.9 mm
M 39.0x0.5	43.0 mm	33.8 mm	6.4 mm
M 40.5x0.5	44.5 mm	35.8 mm	6.4 mm
M 43.0x0.75	47.0 mm	37.8 mm	6.9 mm
M 46.0x0.75	50.0 mm	40.8 mm	6.9 mm
M 49.0x0.75	53.0 mm	43.8 mm	6.9 mm
M 52.0x0.75	56.0 mm	46.8 mm	6.9 mm
M 55.0x0.75	59.0 mm	49.8 mm	6.9 mm
M 58.0x0.75	62.0 mm	52.8 mm	6.9 mm
M 62.0x0.75	66.0 mm	56.8 mm	6.9 mm
M 67.0x0.75	71.0 mm	61.8 mm	6.9 mm

UV/IR Cut 380 - 650 nm

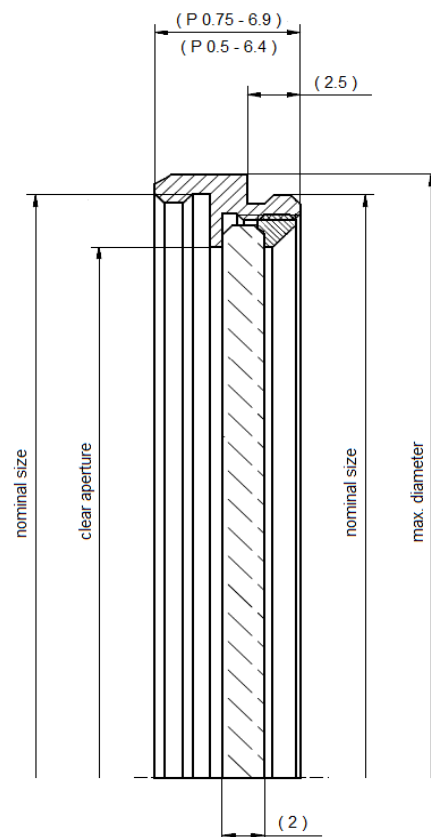

SN1-Mount

The SN1-Mount was designed for the popular M30.5x0.5 thread. With its high clear aperture, vignetting can be avoided even for wide angle applications. The filter is glued into the mount. So it is secured against vibrations when integrated into robots or production lines. It is ideal to be used in automated fabrication. SN1-Mounts have a male and female M-thread and can be stacked if several filters must be combined.

Key features	Applications
<ul style="list-style-type: none"> • Maximum clear aperture • No vignetting • Stackable • Robust • Black anodized brass 	<ul style="list-style-type: none"> • Mounted on lenses • Mounted on measurement instruments

Thread	Diameter	Clear Aperture	Thickness
M 30.5x0.5	32 mm	28 mm	6.5 mm

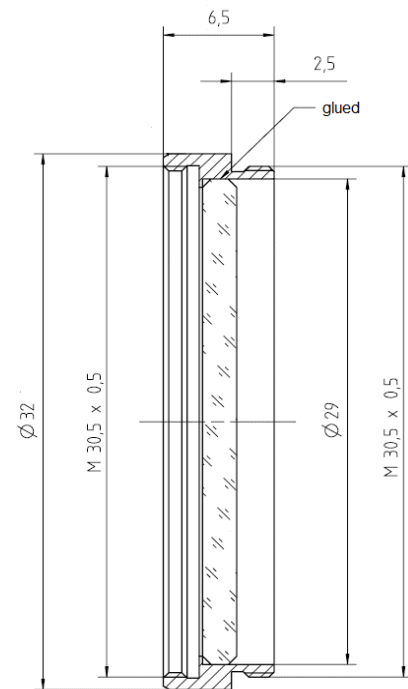

Headquarters Europe

Jos. Schneider Optische Werke GmbH
Ringstraße 132
55543 Bad Kreuznach
+49 671 601 205
isales@schneiderkreuznach.com
www.schneiderkreuznach.com

Offices Worldwide

America

+1 800 645 7239 (East Coast)
+1 800 228 1254 (West Coast)
info@schneideroptics.com

Asia

+86 755 8832 1170
info@schneider-asiapacific.com