

This high resolution lens for sensors up to 32mm diagonal is compact and robust and therefore ideal for demanding imaging applications even in harsh environment. The optical design prevents shading with CRA sensitive sensors and the special broadband AR coating enables the use either in the visible 400 to 700 nm or in the NIR 700 to 1000 nm range. The lens is equipped with a M42 x 1 camera mount.

Key features

- 32mm image circle
- For pixel size down to 2.4 μm
- Suitable for all Sony's Pregius™ generations
- Optimized for long working distances

Applications

- Machine Vision
- AOI (Automated Optical Inspection)
- 3D and 2D measurement
- Robotic Vision

Technical specifications

Type [standard]	M42x1
ID [standard]	1101281
Interface	M42x1
Focal length [mm]	50
F/# range	F/2.8 ... F/16
Numerical aperture [object image]	- 0.18
Max. sensor size [mm]	37.4
Max. angle of view [°]	41
Rec. magnification range	-0.10 ... 0
Rec. working distance range [mm]	510 ... ∞
Min. working distance without extension tubes [mm]	205
Filter thread [mm]	M43 x 0.75
Storage temperature [°C]	-25 ... +70
Net. weight [g]	358
Additional info	-
f'eff [mm]	51.25
SF [mm]	-7.66
S'F' [mm]	19.94
HH' [mm]	-19.04
β' P	1.60
SEP [mm]	24.29
S'AP [mm]	-62.28
Σd [mm]	55.87

MTF charts

Spectrum name	VIS					
Wavelengths [nm]	425	475	525	575	625	675
Rel. weights [%]	8	16	23	22	19	13

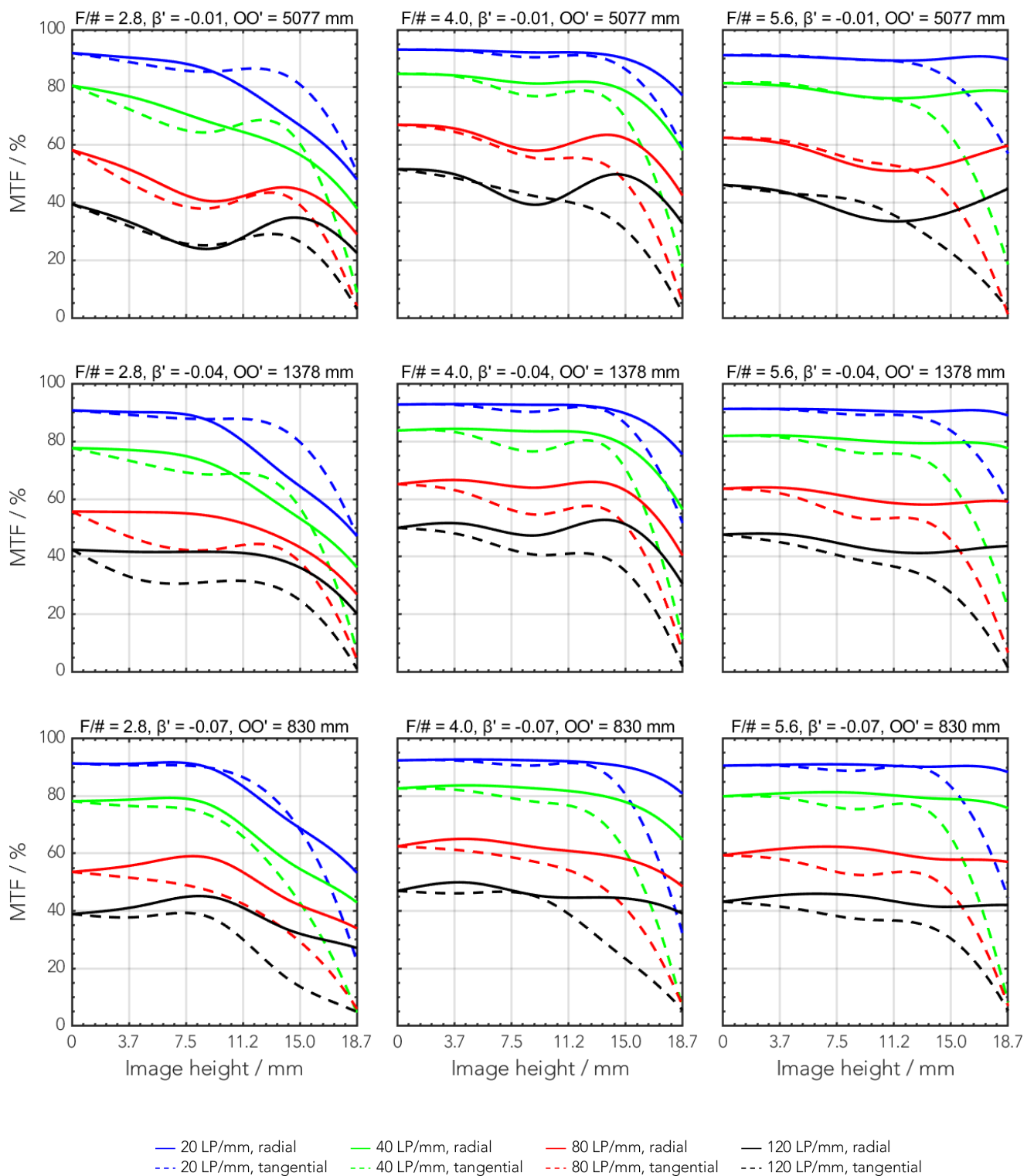

Rel. illumination vs. image height

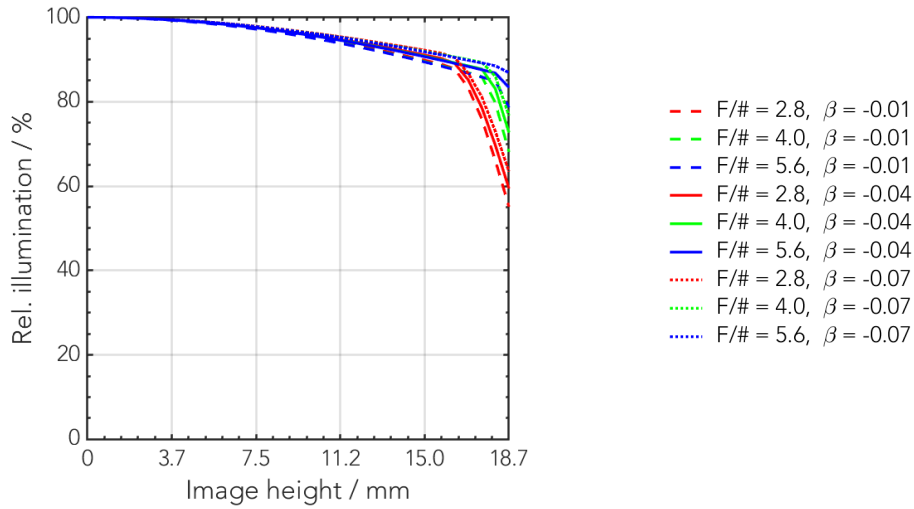

Distortion vs. image height

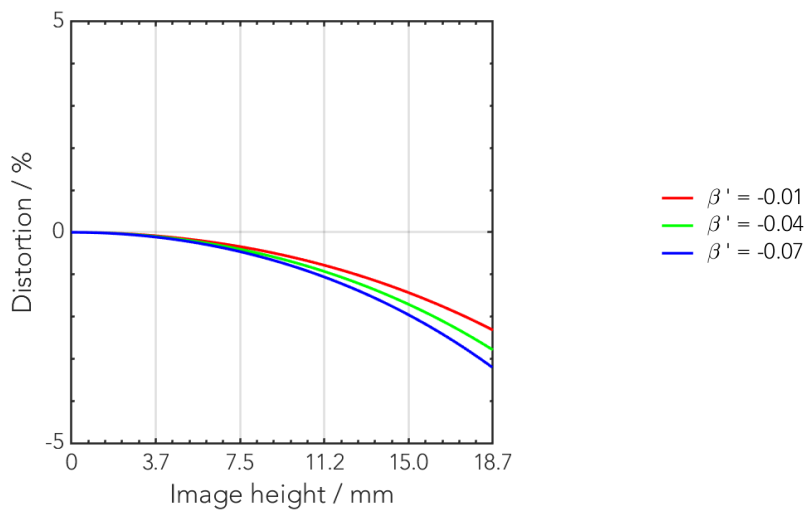

Transmittance vs. wavelength

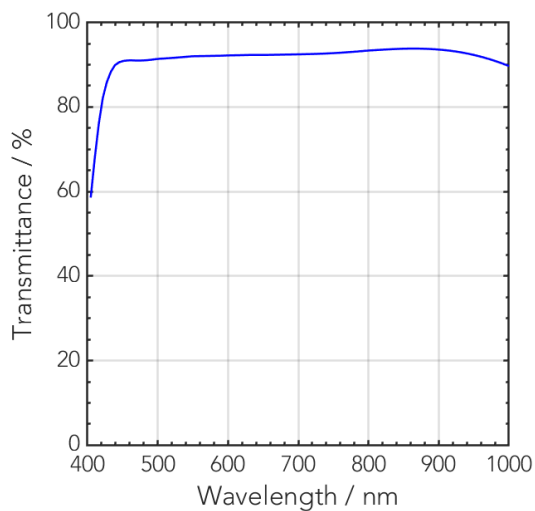

Technical drawings

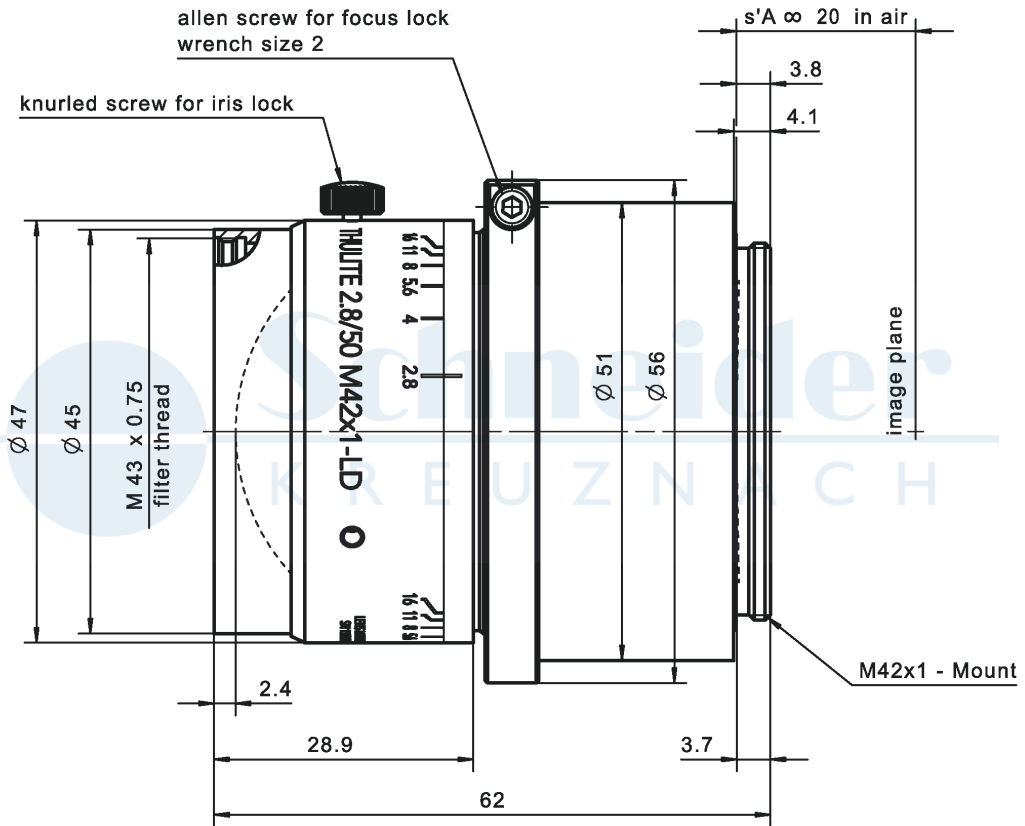

THULITE 2.8/50 M42x1-LD



Accessories	Mount	Eff. length	ID
Extension tube	M42x1 / M42x1	5 mm	1105877
	M42x1 / M42x1	10 mm	1105878

Annotation	
Focal length	Nominal focal length
F/# range	Image space F-number range for infinity focus position
Numerical aperture	Maximum real numerical aperture (depending on recommended magnification range either for infinity or respective fixed magnification)
Max. sensor size	Image circle diameter
Max. angle of view	Angle of view associated with maximum sensor size (depending on recommended magnification range either for infinity or respective fixed magnification)
Rec. magnification range	Magnification range as recommended by Schneider-Kreuznach
Rec. working distance range	Working distance, i.e. distance between object and first mechanical element, associated with recommended magnification range
Max. mechanical focus travel	Maximum possible movement of the lens from infinity position (depending on recommended magnification range either for infinity or respective fixed magnification)
Net weight	weight of unpacked lens without lens cap
f'_{eff}	Effective focal length
SF	Distance between vertex of first lens surface and object space focal point
S'F'	Distance between vertex of last lens surface and image space focal point (back focal distance at infinity)
HH'	Distance between principal planes
$\beta'P$	Pupil magnification (= exit pupil diameter / entrance pupil diameter)
SEP	Distance between vertex of first lens surface and entrance pupil
S'AP	Distance between vertex of last lens surface and exit pupil
Σd	Distance between vertices of first and last lens surface
s'A	Flange focal distance (in air) for infinite object distance (depending on recommended magnification range either for infinity or respective fixed magnification)
β'	Magnification (= image size / object size), negative value because image is inverted
OO'	Distance between object and image

Unless otherwise stated all dimensions in this data sheet are in mm.

Headquarters Europe

Jos. Schneider Optische Werke GmbH

Ringstraße 132

55543 Bad Kreuznach

☎ +49 671 601 205

✉ cs@schneiderkreuznach.com

www.schneiderkreuznach.com

Offices Worldwide

America

☎ +1 800 645 7239 (East Coast)

☎ +1 800 228 1254 (West Coast)

✉ info@schneideroptics.com

Asia

☎ +86 755 8832 1170

✉ info@schneider-asiapacific.com