

This extremely fast 1" C-Mount lens with fixed F0.95 aperture is optimized for demanding low light imaging applications. With its robust mechanical design, fixed iris and locking screw for focus it is usable even in harsh environment.

Key features

- Very large aperture F0.95
- 16mm image circle
- Robust mechanics
- Fixed iris for highest stability

Applications

- Bioluminescence
- Fluorescence
- High speed imaging
- Low light applications

Technical specifications

Type [standard]	C-FI
ID [standard]	1106958
Interface	C-Mount
Focal length [mm]	25
F/# range	F/0.95
Numerical aperture [object image]	- 0.5
Max. sensor size [mm]	16
Max. angle of view [°]	35
Rec. magnification range	-0.1 ... 0
Rec. working distance range [mm]	234 ... ∞
Min. working distance without extension tubes [mm]	133
Filter thread [mm]	M39 x 0.5
Storage temperature [°C]	-25 ... +70
Net. weight [g]	155
Additional info	-
f'eff [mm]	25.63
SF [mm]	16.89
S'F' [mm]	16.24
HH' [mm]	-10.51
β'P	4.10
SEP [mm]	23.15
S'AP [mm]	-88.72
Σd [mm]	41.40

MTF charts

Spectrum name	VIS					
Wavelengths [nm]	425	475	525	575	625	675
Rel. weights [%]	8	16	23	22	19	13

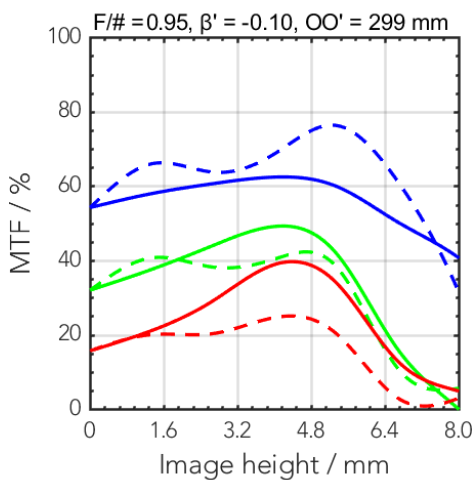
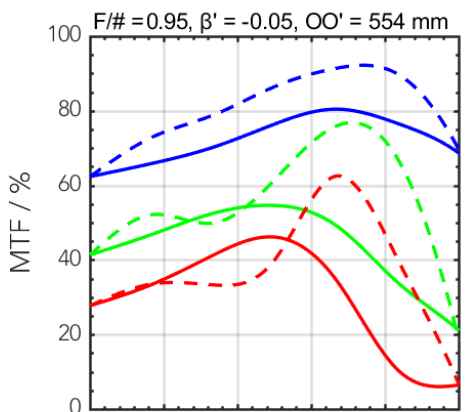
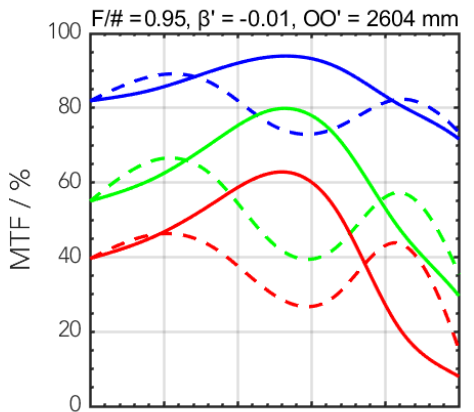

— 10 LP/mm, radial
 - - 10 LP/mm, tangential

— 20 LP/mm, radial
 - - 20 LP/mm, tangential

— 40 LP/mm, radial
 - - 40 LP/mm, tangential

Rel. illumination vs. image height

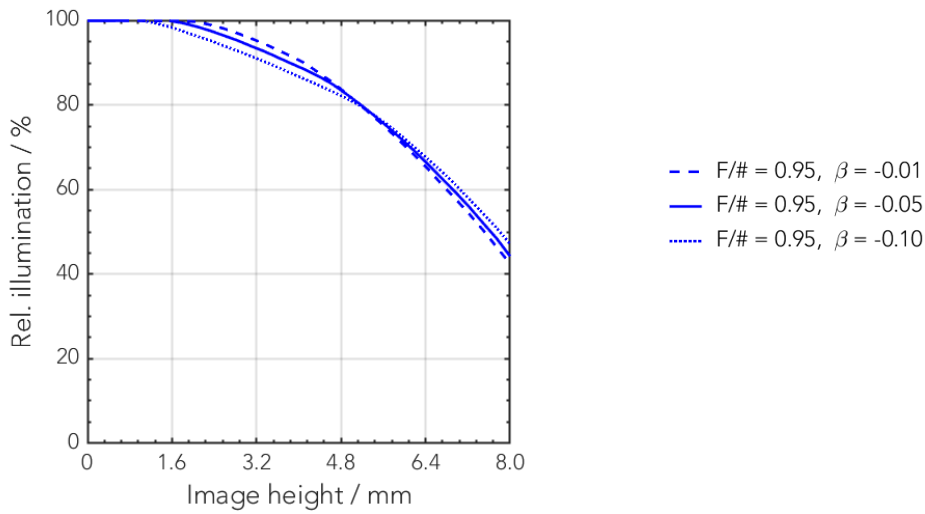

Distortion vs. image height

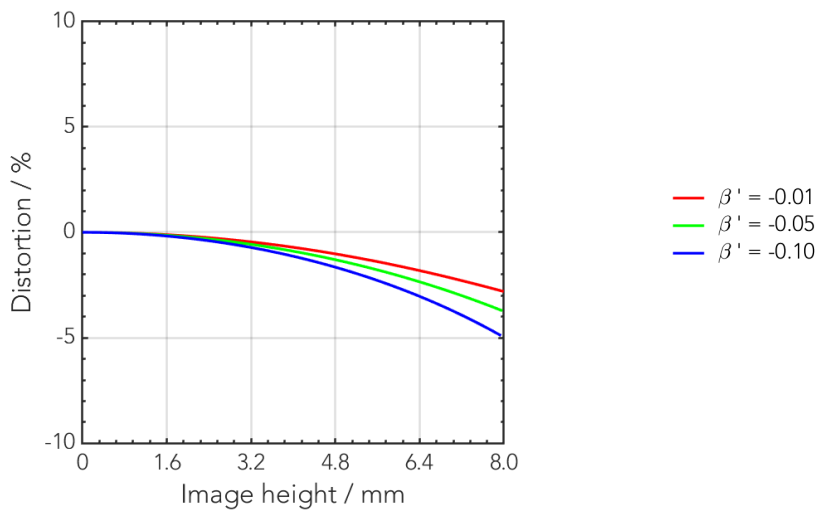

Transmittance vs. wavelength

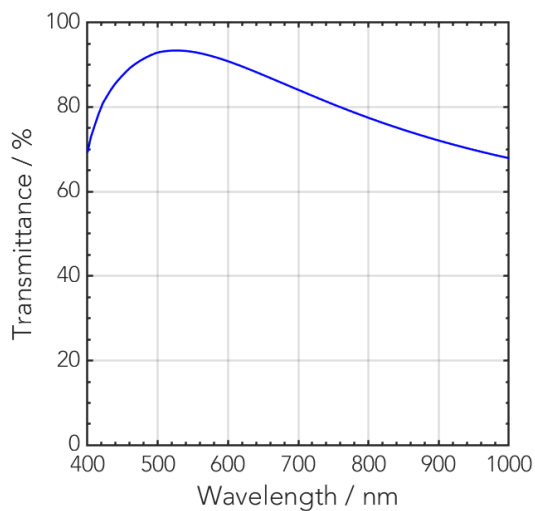

Technical drawings

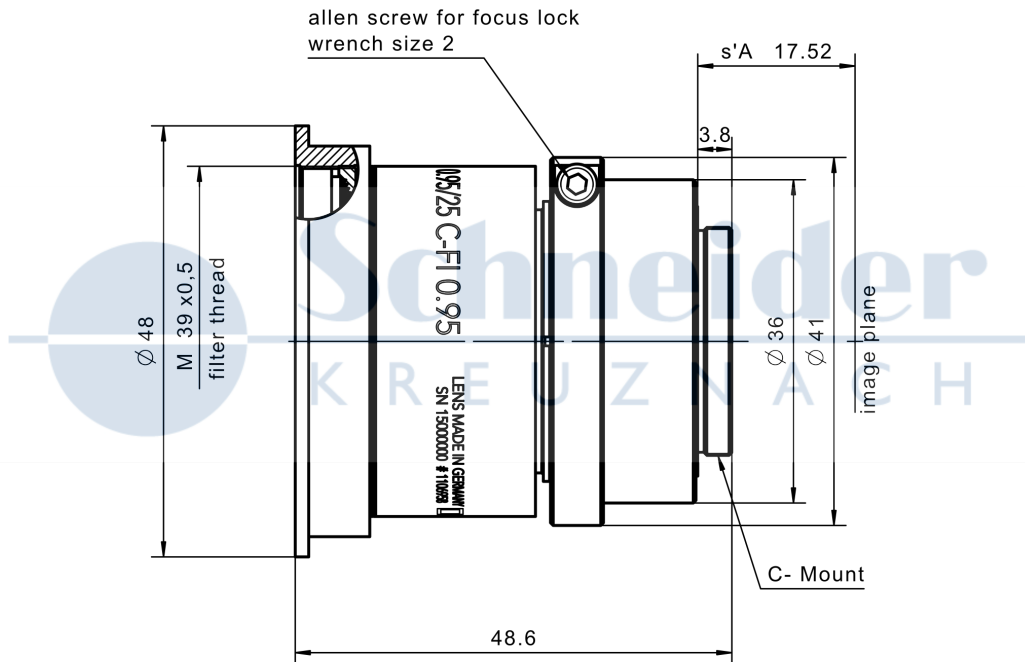

Accessories	Mount	Eff. length	ID
Adapter	CS-Mount	5 mm	25081
	C-Mount / M42x1	5.5 mm	1075817
Extension tube	C-Mount / C-Mount	5 mm	39316
	C-Mount / C-Mount	8 mm	39315
	C-Mount / C-Mount	10 mm	39312

Annotation	
Focal length	Nominal focal length
F/# range	Image space F-number range for infinity focus position
Numerical aperture	Maximum real numerical aperture (depending on recommended magnification range either for infinity or respective fixed magnification)
Max. sensor size	Image circle diameter
Max. angle of view	Angle of view associated with maximum sensor size (depending on recommended magnification range either for infinity or respective fixed magnification)
Rec. magnification range	Magnification range as recommended by Schneider-Kreuznach
Rec. working distance range	Working distance, i.e. distance between object and first mechanical element, associated with recommended magnification range
Max. mechanical focus travel	Maximum possible movement of the lens from infinity position (depending on recommended magnification range either for infinity or respective fixed magnification)
Net weight	weight of unpacked lens without lens cap
f'_{eff}	Effective focal length
SF	Distance between vertex of first lens surface and object space focal point
S'F'	Distance between vertex of last lens surface and image space focal point (back focal distance at infinity)
HH'	Distance between principal planes
$\beta'P$	Pupil magnification (= exit pupil diameter / entrance pupil diameter)
SEP	Distance between vertex of first lens surface and entrance pupil
S'AP	Distance between vertex of last lens surface and exit pupil
Σd	Distance between vertices of first and last lens surface
s'A	Flange focal distance (in air) for infinite object distance (depending on recommended magnification range either for infinity or respective fixed magnification)
β'	Magnification (= image size / object size), negative value because image is inverted
OO'	Distance between object and image

Unless otherwise stated all dimensions in this data sheet are in mm.

Headquarters Europe

Jos. Schneider Optische Werke GmbH

Ringstraße 132

55543 Bad Kreuznach

☎ +49 671 601 205

✉ cs@schneiderkreuznach.com

www.schneiderkreuznach.com

Offices Worldwide

America

☎ +1 800 645 7239 (East Coast)

☎ +1 800 228 1254 (West Coast)

✉ info@schneideroptics.com

Asia

☎ +86 755 8832 1170

✉ info@schneider-asiapacific.com