

This vibration insensitive lens is designed to be used with large area and line scan sensors under harsh conditions as in many industrial applications. Very low chromatic aberrations plus low geometric distortion provide a very high image quality from edge to edge at a wide magnifications range. The V38-Mount fits to the modular Unifoc system with its large variety of accessories, including focusing mounts, extension tubes and camera adapters.

Key features

- Modular system
- Low distortion
- Low chromatic aberrations
- Large image circle

Applications

- Machine Vision
- AOI (Automated Optical Inspection)
- FPD/PCB inspection
- Logistics

Technical specifications

Type [standard]	V38
ID [standard]	1097782
Interface	V38-Mount
Focal length [mm]	35
F/# range	F/2.8 ... F/22
Numerical aperture [object image]	- 0.18
Max. sensor size [mm]	30
Max. angle of view [°]	47
Rec. magnification range	-0.5 ... 0
Rec. working distance range [mm]	77 ... ∞
Max. mechanical focus travel [mm]	-
Filter thread [mm]	M37 x 0.75
Storage temperature [°C]	-25 ... +70
Net. weight [standard] [g]	108
Additional info	-
f'eff [mm]	34.93
SF [mm]	-19.45
S'F' [mm]	24.77
HH' [mm]	-3.54
β'P	1.05
SEP [mm]	13.92
S'AP [mm]	-11.79
Σd [mm]	22.09

MTF charts

Spectrum name	VIS					
Wavelengths [nm]	425	475	525	575	625	675
Rel. weights [%]	8	16	23	22	19	13

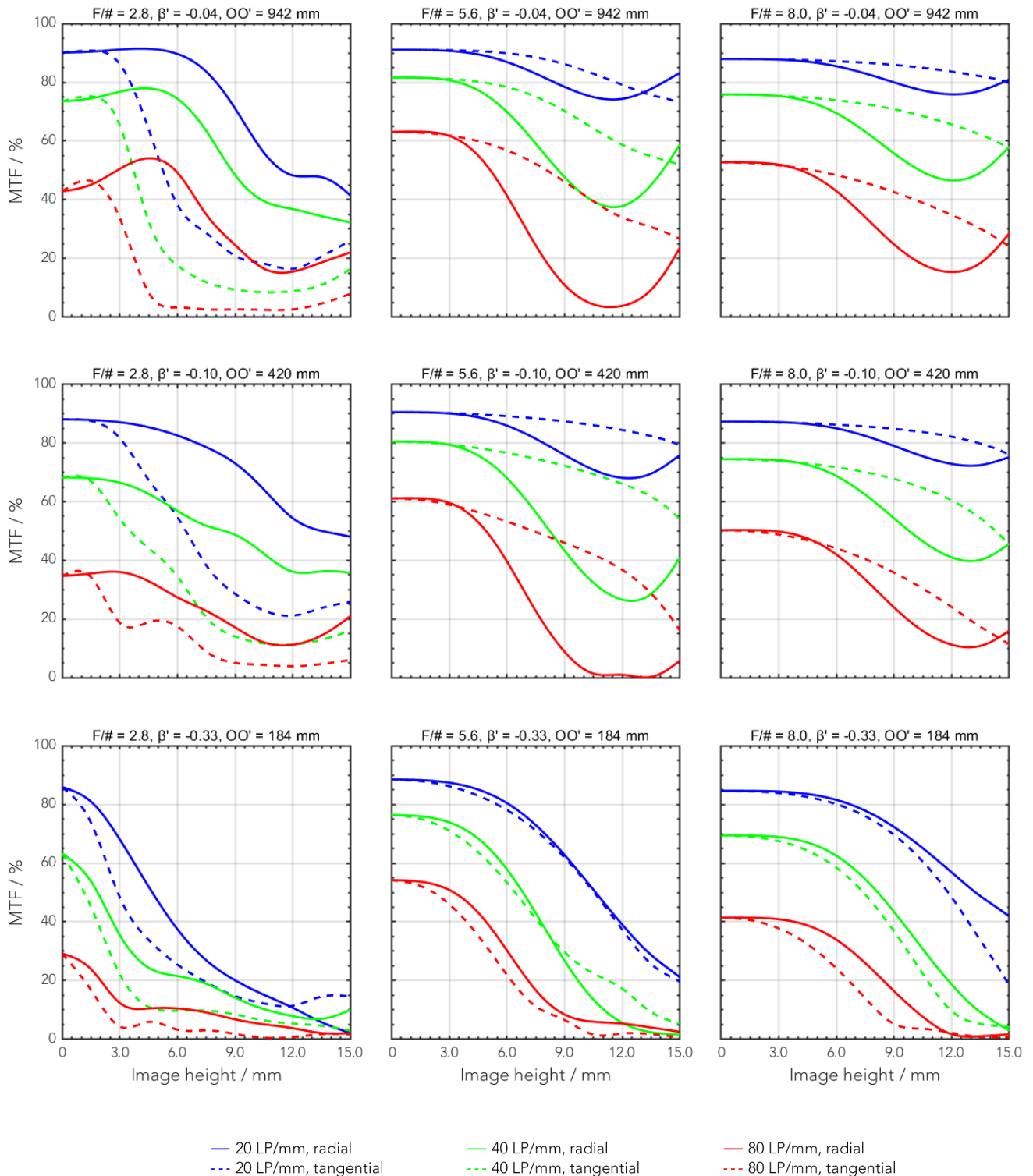

Rel. illumination vs. image height

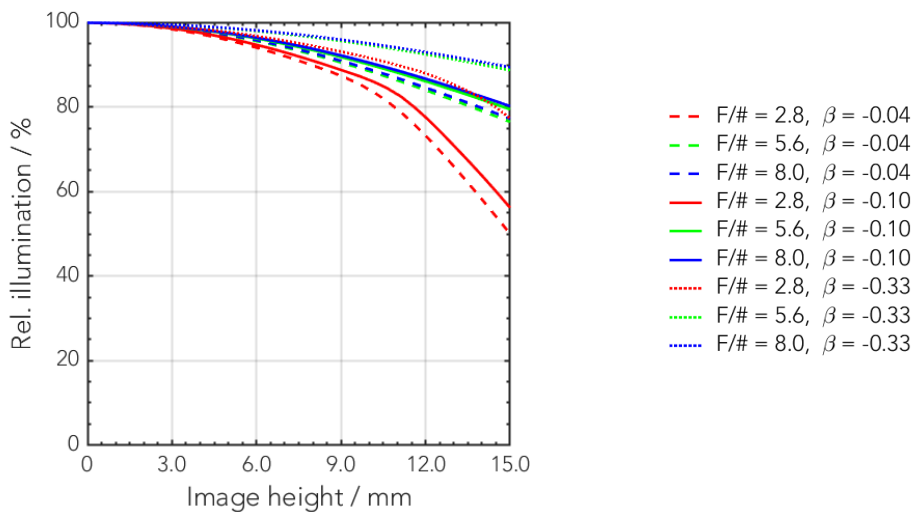

Distortion vs. image height

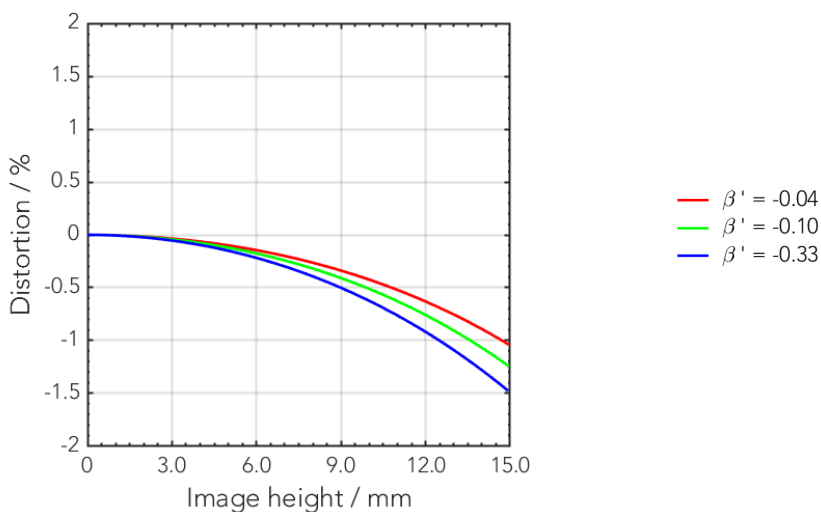

Transmittance vs. wavelength

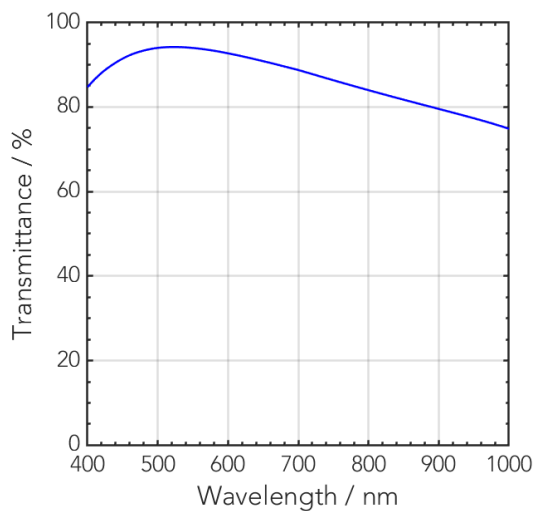

Technical drawings

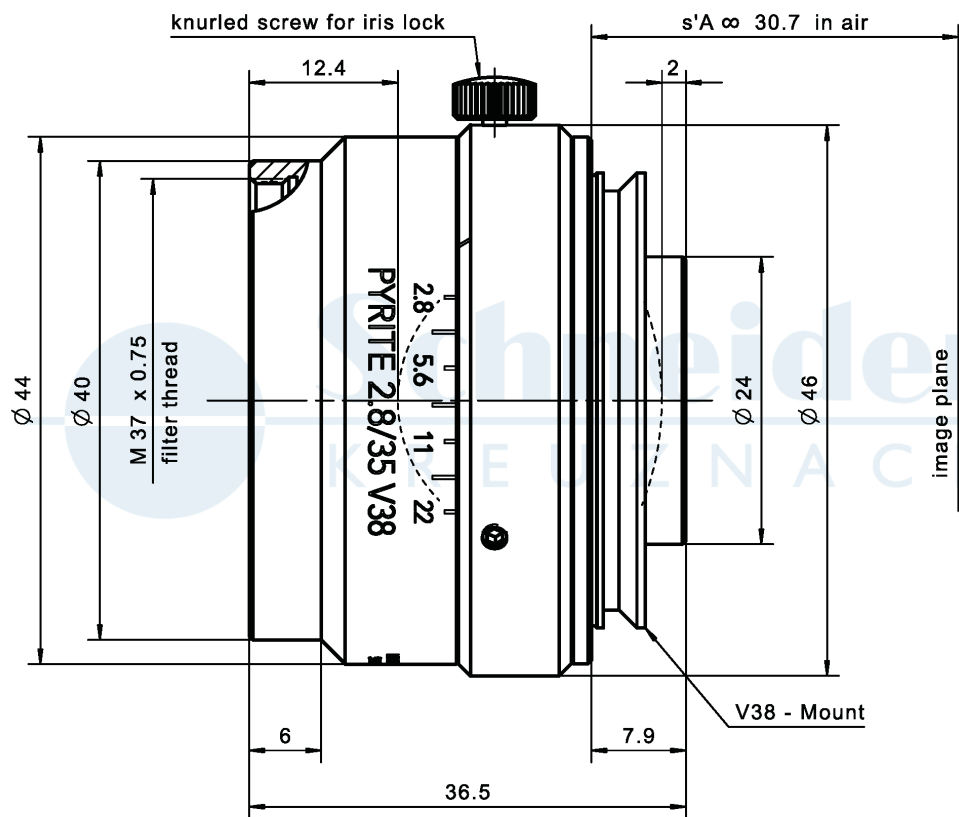

Accessories	Mount	Eff. length	ID
UNIFOC 12	V38 / V38	17.4 – 29.4 mm	11726
UNIFOC 7	V38 / V38	20 – 27 mm	1001041
UNIFOC 7	V38 / M58 x 0.75	20 – 27 mm	1054532
UNIFOC 5	V38 / C-Mount	19.2 – 24.2 mm	1011634
Adapter	V38 / C-Mount	6.5 mm	20052
	V38 / TFL-Mount	6.5 mm	1098491
	V38 / Leica	6.5 mm	20054
	V38 / M42 x 0.75	6.5 mm	20053
	V38 / M42 x 1	6.5 mm	20059
	V38 / M42 x 1	35 mm	1001692
	V38 / M58 x 0.75	10 mm	1018385
	V38 / F-Mount	9.3 mm	21610
Extension tube	V38 / V38	6 mm	20176
	V38 / V38	8 mm	20177
	V38 / V38	10 mm	20178
	V38 / V38	25 mm	20179
	V38 / V38	50 mm	20154
	V38 / V38	75 mm	20155

Annotation	
Focal length	Nominal focal length
F/# range	Image space F-number range for infinity focus position
Numerical aperture	Maximum real numerical aperture (depending on recommended magnification range either for infinity or respective fixed magnification)
Max. sensor size	Image circle diameter
Max. angle of view	Angle of view associated with maximum sensor size (depending on recommended magnification range either for infinity or respective fixed magnification)
Rec. magnification range	Magnification range as recommended by Schneider-Kreuznach
Rec. working distance range	Working distance, i.e. distance between object and first mechanical element, associated with recommended magnification range
Max. mechanical focus travel	Maximum possible movement of the lens from infinity position (depending on recommended magnification range either for infinity or respective fixed magnification)
Net weight	weight of unpacked lens without lens cap
f'_{eff}	Effective focal length
SF	Distance between vertex of first lens surface and object space focal point
S'F'	Distance between vertex of last lens surface and image space focal point (back focal distance at infinity)
HH'	Distance between principal planes
$\beta'P$	Pupil magnification (= exit pupil diameter / entrance pupil diameter)
SEP	Distance between vertex of first lens surface and entrance pupil
S'AP	Distance between vertex of last lens surface and exit pupil
Σd	Distance between vertices of first and last lens surface
s'A	Flange focal distance (in air) for infinite object distance (depending on recommended magnification range either for infinity or respective fixed magnification)
β'	Magnification (= image size / object size), negative value because image is inverted
OO'	Distance between object and image

Unless otherwise stated all dimensions in this data sheet are in mm.

Headquarters Europe

Jos. Schneider Optische Werke GmbH

Ringstraße 132

55543 Bad Kreuznach

☎ +49 671 601 205

✉ cs@schneiderkreuznach.com

www.schneiderkreuznach.com

Offices Worldwide

America

☎ +1 800 645 7239 (East Coast)

☎ +1 800 228 1254 (West Coast)

✉ info@schneideroptics.com

Asia

☎ +86 755 8832 1170

✉ info@schneider-asiapacific.com