

Bandpass Filters

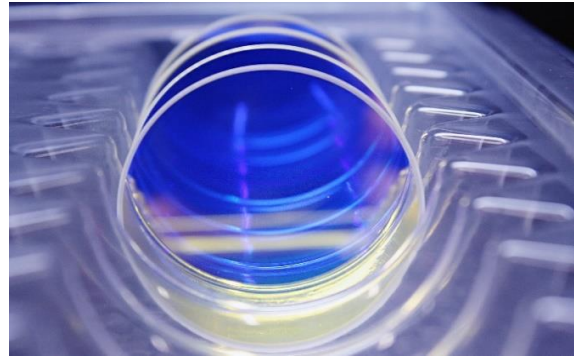

Schneider-Kreuznach magnetron sputtered industrial bandpass filters impress with steep slopes and high transmission at stable cut-on and cut-off wavelengths. The very flat surface makes them ideal for high end inspection systems. Schneider-Kreuznach bandpass filters are RoHS conform. Custom sizes are available on request.



Key features	Applications
<ul style="list-style-type: none"> • Average transmittance 95% • Steep slopes • Wavelength tolerance +/- 1% • Deep blocking / High optical density 	<ul style="list-style-type: none"> • Automation • 3D Measurement • Food and beverage inspection • Ophthalmology • Microscopy • Robotics

Standrad Products		available on request	
Name	Description	Name	Description
BP 465-70 HT	Bandpass 430 - 500 nm	BP 490-80 HT	Bandpass 400 - 580 nm
BP 540-80 HT	Bandpass 495 - 580 nm	BP 515-270 HT	UV/IR Cut 380 - 650 nm former UI 515
BP 540-300 HT	UV/IR Cut 390 - 690 nm	BP 520-280 HT	UV/IR Cut 380 - 660 nm
BP 575-170 HT	Bandpass 495 - 660 nm	VIS-85	400 - 650 nm & 800 - 900 nm
BP 590-50 HT	Bandpass 565 - 615 nm	BP 590-200 HT	Bandpass 595 - 690 nm
BP 635-50 HT	Bandpass 610 - 660 nm	BP 640-100 HT	Bandpass 590 - 590 nm
BP 660-60 HT	Bandpass 630 - 690 nm	BP 680-100 HT	Bandpass 630 - 730 nm
BP 850-80 HT	Bandpass 810 - 890 nm		
BP 865-100 HT	Bandpass 815 - 915 nm		

Bandpass 465-70 HT

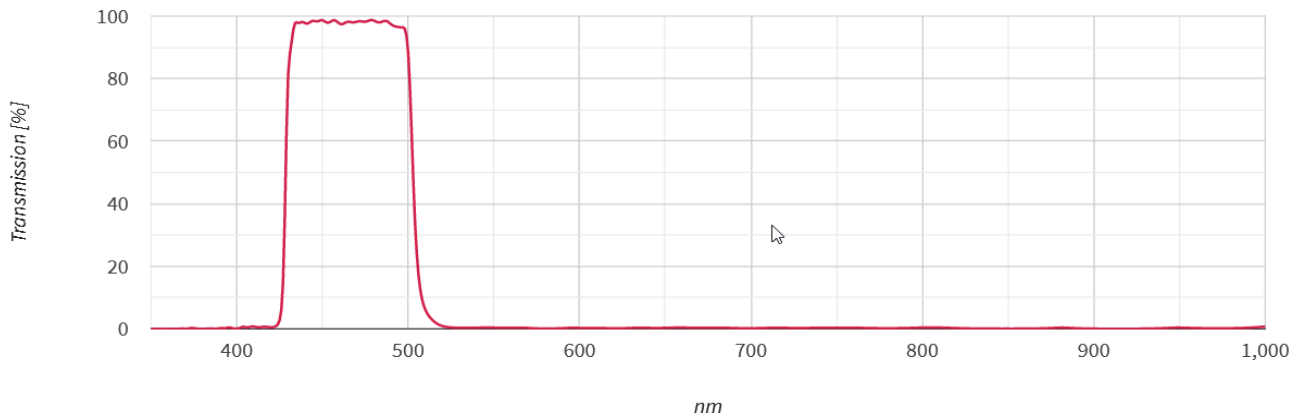

Technical specifications	according to ISO 10110
Angle of incident	0° +/- 8°
Cut-on wavelength	430 +/- 5 nm
Cut-off wavelength	550 +/- 5 nm
Transmittance	400 - 490 nm: T _{ave} > 95%
	400 - 490 nm: T _{abs} > 90%
Blocking	< 390 nm: T _{abs} < 0.5%
	530 - 1000 nm: T _{abs} < 1.0%
Parallelism	1'
Wavefront distortion	Ø >18 - 30 mm: 13/ 1(0.25)
	Ø >30 - 50 mm: 13/ 1(0.30)
Glass Thickness	1.0 +/- 0.08mm
	2.0 +/- 0.08mm

Mounted Filter			Unmounted Filterglass		
IF BP 465-70 HT <i>Mount Thickness</i>			IFG BP 465-70 HT <i>Diameter thickness</i>		
Mount	Thickness	ID	Diameter	Thickness	ID
CMT	2mm	1082875	22.0 mm	2mm	1091131
CMT	1mm	<i>ID to be defined</i>	22.0 mm	1mm	<i>ID to be defined</i>
SH 25.5	2mm	1084483	23.0 mm	2mm	<i>ID to be defined</i>
SH 25.5	1mm	<i>On request only</i>	23.0 mm	1mm	<i>On request only</i>
SH 27.0	2mm	1085601	24.0 mm	2mm	<i>ID to be defined</i>
SH 27.0	1mm	<i>On request only</i>	24.0 mm	1mm	<i>On request only</i>
SN1 30.5	2mm	1082876	29.0 mm	2mm	1093541
SN1 30.5	1mm	<i>On request only</i>	29.0 mm	1mm	<i>On request only</i>
SH 34.0	2mm	<i>ID to be defined</i>	31.0 mm	2mm	<i>ID to be defined</i>
SH 34.0	1mm	<i>On request only</i>	31.0 mm	1mm	<i>On request only</i>
SH 35.5	2mm	1085700	33.0 mm	2mm	<i>ID to be defined</i>
SH 35.5	1mm	<i>On request only</i>	33.0 mm	1mm	<i>On request only</i>
SH 37.0	2mm	1085384	34.0 mm	2mm	1082452
SH 37.0	1mm	<i>On request only</i>	34.0 mm	1mm	1095261
SH 39.0	2mm	<i>ID to be defined</i>	36.0 mm	2mm	<i>ID to be defined</i>
SH 40.5	2mm	1085701	38.0 mm	2mm	<i>ID to be defined</i>
SH 43.0	2mm	1085702	40.0 mm	2mm	<i>ID to be defined</i>
SH 46.0	2mm	1090027	43.0 mm	2mm	1082453
SH 49.0	2mm	1089142	46.0 mm	2mm	<i>ID to be defined</i>

Custom sizes are available on request.

Example: *IF BP 465-70 HT SH 25.5 2*

Custom sizes are available on request.

Example: *IFG BP 465-70 HT 23.0 2*

Bandpass 490-180 HT - on request

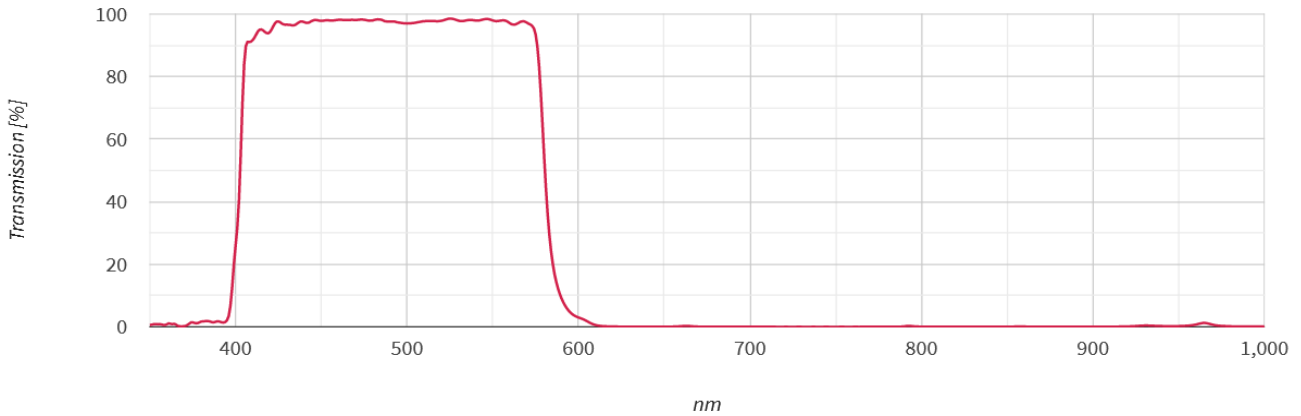

Technical specifications	according to ISO 10110
Angle of incident	0° +/- 8°
Cut-on wavelength	400 +/- 5 nm
Cut-off wavelength	580 +/- 6 nm
Transmittance	415 - 565 nm: $T_{ave} > 95\%$
	415 - 565 nm: $T_{abs} > 90\%$
Blocking	< 370 nm: $T_{abs} < 1.0\%$
	615 - 950 nm: $T_{abs} < 1.0\%$
	950 - 1100 nm: $T_{abs} < 2.0\%$
Parallelism	1'
Wavefront distortion	Ø >18 - 30 mm: 13/ 1(0.25)
	Ø >30 - 50 mm: 13/ 1(0.30)

Bandpass 515-270 HT - on request

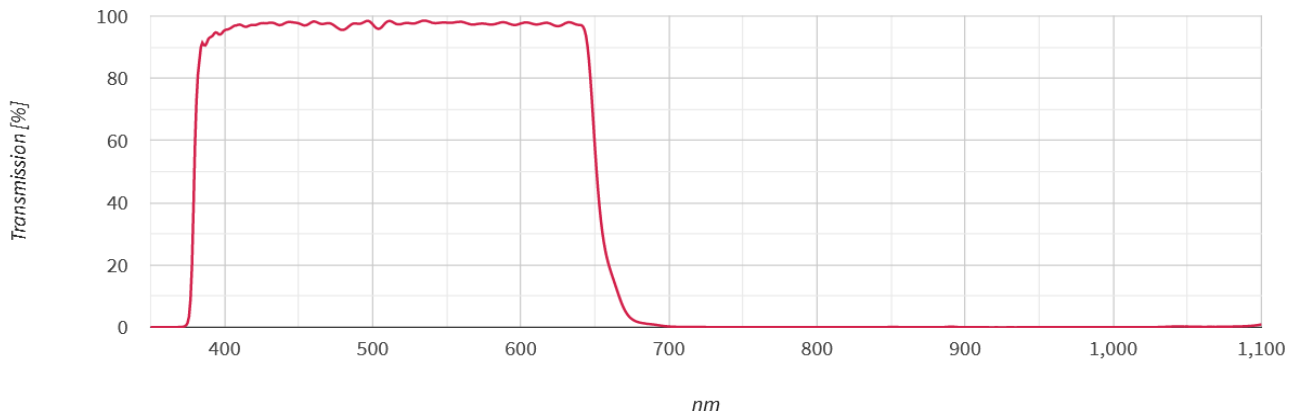

Technical specifications	according to ISO 10110
Angle of incident	0° +/- 8°
Cut-on wavelength	380 +/- 5 nm
Cut-off wavelength	650 +/- 7 nm
Transmittance	410 - 630 nm: $T_{ave} > 95\%$ 400 - 630 nm: $T_{abs} > 90\%$
Blocking	< 365 nm: $T_{abs} < 1.0\%$ 700 - 1050 nm: $T_{abs} < 1.0\%$
Parallelism	1'
Wavefront distortion	$\varnothing > 18 - 30$ mm: 13/ 1(0.25) $\varnothing > 30 - 50$ mm: 13/ 1(0.30)

Bandpass 520-280 HT - on request

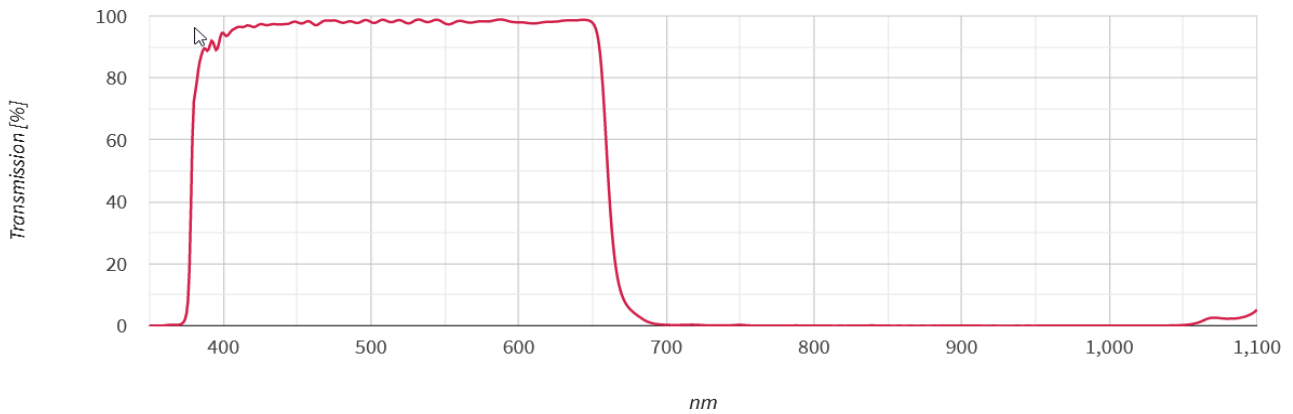

Technical specifications	according to ISO 10110
Angle of incident	0° +/- 8°
Cut-on wavelength	380 +/- 5 nm
Cut-off wavelength	660 +/- 7 nm
Transmittance	420 - 640 nm: $T_{ave} > 95\%$
	420 - 640 nm: $T_{abs} > 90\%$
Blocking	< 365 nm: $T_{abs} < 1.0\%$
	710 - 1050 nm: $T_{abs} < 1.0\%$
Parallelism	1'
Wavefront distortion	Ø >18 - 30 mm: 13/ 1(0.25)
	Ø >30 - 50 mm: 13/ 1(0.30)

Bandpass 540-80 HT

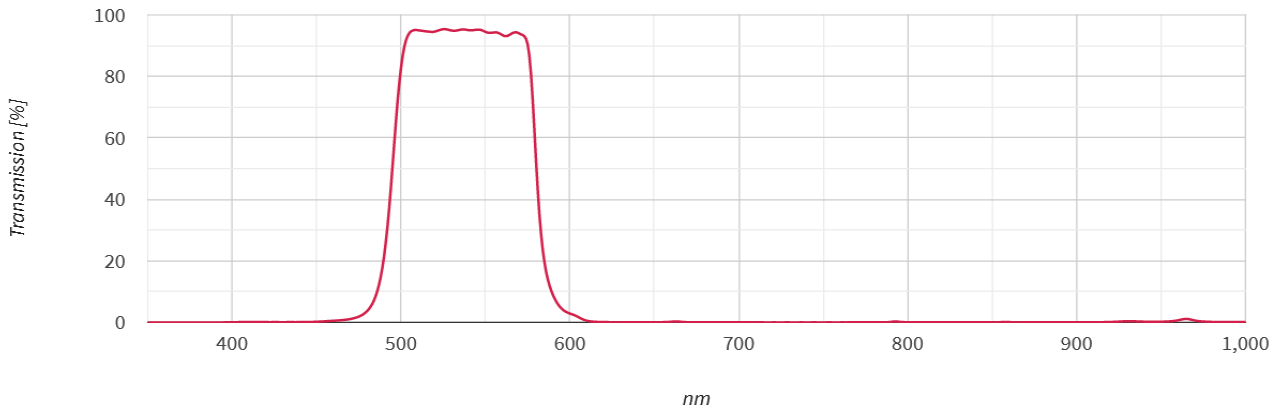

Technical specifications	according to ISO 10110
Angle of incident	0° +/- 8°
Cut-on wavelength	495 +/- 5 nm
Cut-off wavelength	580 +/- 6 nm
Transmittance	515 - 565 nm: $T_{abs} > 90\%$ < 450 nm: $T_{abs} < 0.5\%$
Blocking	615 - 950 nm: $T_{abs} < 1.0\%$ 950 - 1100 nm: $T_{abs} < 2.0\%$
Parallelism	1'
Wavefront distortion	Ø >18 - 30 mm: 13/ 1(0.25) Ø >30 - 50 mm: 13/ 1(0.30)
Glass Thickness	1.0 +/- 0.08mm 2.0 +/- 0.08mm

Mounted Filter			Unmounted Filterglass		
IF BP 540-80 HT <i>Mount Thickness</i>			IFG BP 540-80 HT <i>Diameter thickness</i>		
Mount	Thickness	ID	Diameter	Thickness	ID
CMT	2mm	1084907	22.0 mm	2mm	1099704
CMT	1mm	<i>ID to be defined</i>	22.0 mm	1mm	<i>ID to be defined</i>
SH 25.5	2mm	1085703	23.0 mm	2mm	<i>ID to be defined</i>
SH 25.5	1mm	<i>On request only</i>	23.0 mm	1mm	<i>On request only</i>
SH 27.0	2mm	1085186	24.0 mm	2mm	<i>ID to be defined</i>
SH 27.0	1mm	<i>On request only</i>	24.0 mm	1mm	<i>On request only</i>
SN1 30.5	2mm	1085645	29.0 mm	2mm	<i>ID to be defined</i>
SN1 30.5	1mm	<i>On request only</i>	29.0 mm	1mm	<i>On request only</i>
SH 34.0	2mm	<i>ID to be defined</i>	31.0 mm	2mm	<i>ID to be defined</i>
SH 34.0	1mm	<i>On request only</i>	31.0 mm	1mm	<i>On request only</i>
SH 35.5	2mm	1088049	33.0 mm	2mm	<i>ID to be defined</i>
SH 35.5	1mm	<i>On request only</i>	33.0 mm	1mm	<i>On request only</i>
SH 37.0	2mm	1085385	34.0 mm	2mm	1082572
SH 37.0	1mm	<i>On request only</i>	34.0 mm	1mm	<i>ID to be defined</i>
SH 39.0	2mm	1098137	36.0 mm	2mm	<i>ID to be defined</i>
SH 40.5	2mm	1085704	38.0 mm	2mm	<i>ID to be defined</i>
SH 43.0	2mm	1085705	40.0 mm	2mm	<i>ID to be defined</i>
SH 46.0	2mm	1086645	43.0 mm	2mm	1082573
SH 49.0	2mm	1095223	46.0 mm	2mm	<i>ID to be defined</i>

Custom sizes are available on request.

Example: IF BP 540-80 HT SH 25.5 2

Custom sizes are available on request.

Example: IFG BP 540-80 HT 23.0 2

Bandpass 540-300 HT

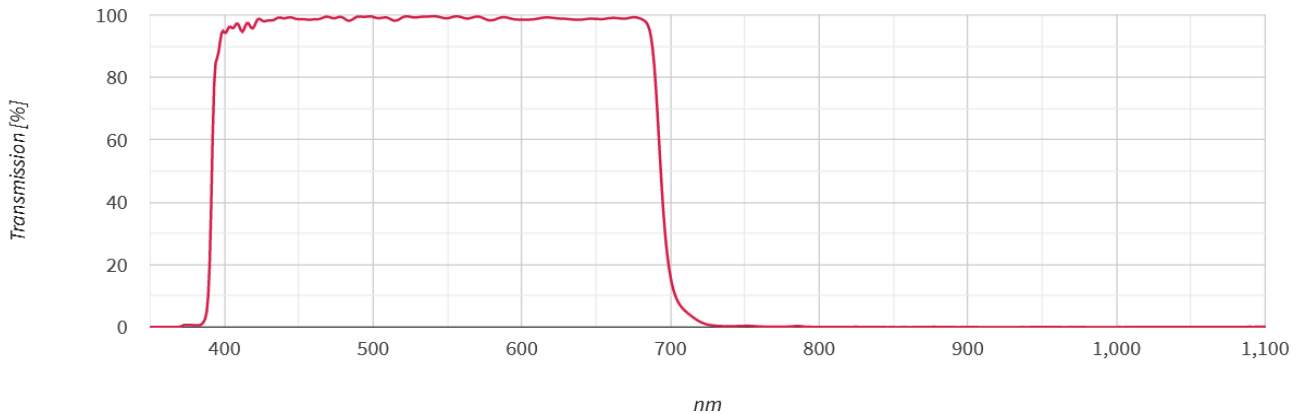

Technical specifications	according to ISO 10110
Angle of incident	0° +/- 8°
Cut-on wavelength	390 +/- 5 nm
Cut-off wavelength	690 +/- 7 nm
Transmittance	425 - 670 nm: $T_{ave} > 95\%$
	405 - 670 nm: $T_{abs} > 90\%$
	< 350 nm: $T_{abs} < 0.5\%$
Blocking	735 - 1100 nm: $T_{ave} < 0.5\%$
	735 - 1100 nm: $T_{abs} < 1.0\%$
Parallelism	1'
Wavefront distortion	Ø >18 - 30 mm: 13/ 1(0.25)
	Ø >30 - 50 mm: 13/ 1(0.30)
Glass Thickness	1.0 +/- 0.08mm
	2.0 +/- 0.08mm

Mounted Filter			Unmounted Filterglass		
IF BP 540-300 HT <i>Mount Thickness</i>			IFG BP 540-300 HT <i>Diameter thickness</i>		
Mount	Thickness	ID	Diameter	Thickness	ID
CMT	2mm	1085677	22.0 mm	2mm	ID to be defined
CMT	1mm	1099824	22.0 mm	1mm	<i>ID to be defined</i>
SH 25.5	2mm	1085602	23.0 mm	2mm	<i>ID to be defined</i>
SH 25.5	1mm	<i>On request only</i>	23.0 mm	1mm	<i>On request only</i>
SH 27.0	2mm	1085603	24.0 mm	2mm	<i>ID to be defined</i>
SH 27.0	1mm	<i>On request only</i>	24.0 mm	1mm	<i>On request only</i>
SN1 30.5	2mm	1085646	29.0 mm	2mm	ID to be defined
SN1 30.5	1mm	<i>On request only</i>	29.0 mm	1mm	<i>On request only</i>
SH 34.0	2mm	<i>ID to be defined</i>	31.0 mm	2mm	<i>ID to be defined</i>
SH 34.0	1mm	<i>On request only</i>	31.0 mm	1mm	<i>On request only</i>
SH 35.5	2mm	1085607	33.0 mm	2mm	<i>ID to be defined</i>
SH 35.5	1mm	<i>On request only</i>	33.0 mm	1mm	<i>On request only</i>
SH 37.0	2mm	1087383	34.0 mm	2mm	1082458
SH 37.0	1mm	<i>On request only</i>	34.0 mm	1mm	1099539
SH 39.0	2mm	1085511	36.0 mm	2mm	<i>ID to be defined</i>
SH 40.5	2mm	1085604	38.0 mm	2mm	<i>ID to be defined</i>
SH 43.0	2mm	1085608	40.0 mm	2mm	<i>ID to be defined</i>
SH 46.0	2mm	1085030	43.0 mm	2mm	1082459
SH 49.0	2mm	1091115	46.0 mm	2mm	<i>ID to be defined</i>

Custom sizes are available on request.

Example: IF BP 540-300 HT SH 25.5 2

Custom sizes are available on request.

Example: IFG BP 540-300 HT 23.0 2

VIS 85 - on request

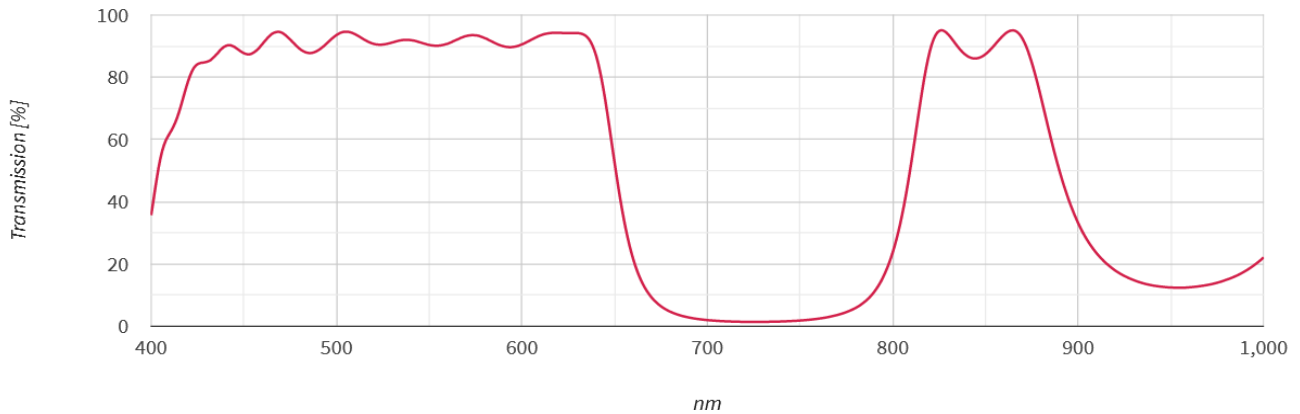

Technical specifications	according to ISO 10110
Angle of incident	0° +/- 8°
Transmittance	450 - 620 nm: $T_{ave} > 90\%$
	450 - 620 nm: $T_{abs} > 85\%$
	850 - 865 nm: $T_{abs} > 85\%$
Blocking	350 - 390 nm: $T_{abs} < 5.0\%$
	670 - 800 nm: $T_{abs} < 3.0\%$
	910 - 1090 nm: $T_{abs} < 5.0\%$
Parallelism	1'
Wavefront distortion	∅ >18 - 30 mm: 13/ 1(0.25)
	∅ >30 - 50 mm: 13/ 1(0.30)

Bandpass 575-170 HT

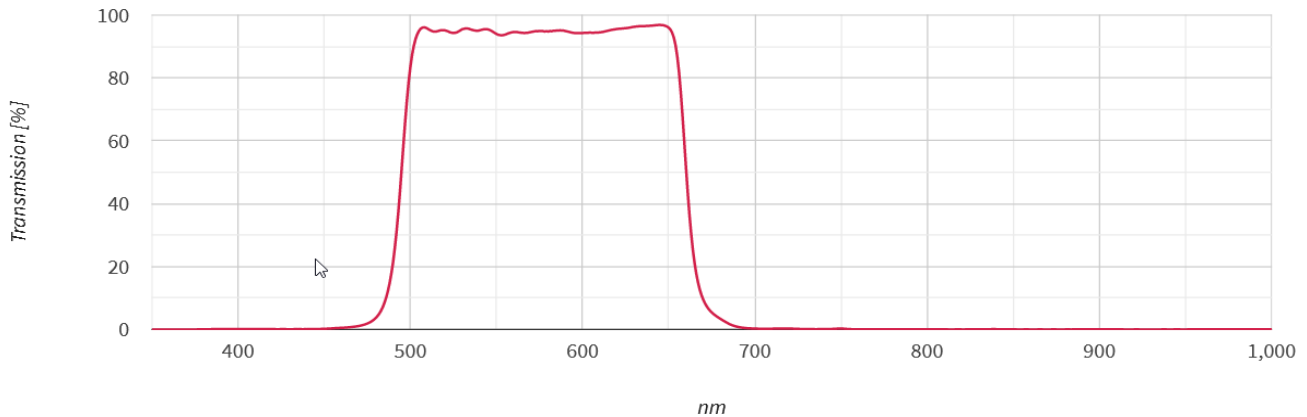

Technical specifications	according to ISO 10110
Angle of incident	0° +/- 8°
Cut-on wavelength	495 +/- 5 nm
Cut-off wavelength	660 +/- 7 nm
Transmittance	515 - 640 nm: T _{abs} > 90%
Blocking	< 450 nm: T _{abs} < 0.5%
	710 - 1050 nm: T _{abs} < 1.0%
Parallelism	1'
Wavefront distortion	Ø >18 - 30 mm: 13/ 1(0.25)
	Ø >30 - 50 mm: 13/ 1(0.30)
Glass Thickness	1.0 +/- 0.08mm
	2.0 +/- 0.08mm

Mounted Filter			Unmounted Filterglass		
IF BP 575-170 HT <i>Mount Thickness</i>			IFG BP 575-170 HT <i>Diameter thickness</i>		
Mount	Thickness	ID	Diameter	Thickness	ID
CMT	2mm	1085678	22.0 mm	2mm	ID to be defined
CMT	1mm	ID to be defined	22.0 mm	1mm	ID to be defined
SH 25.5	2mm	1085451	23.0 mm	2mm	ID to be defined
SH 25.5	1mm	On request only	23.0 mm	1mm	On request only
SH 27.0	2mm	1090034	24.0 mm	2mm	ID to be defined
SH 27.0	1mm	On request only	24.0 mm	1mm	On request only
SN1 30.5	2mm	1085647	29.0 mm	2mm	ID to be defined
SN1 30.5	1mm	On request only	29.0 mm	1mm	On request only
SH 34.0	2mm	ID to be defined	31.0 mm	2mm	ID to be defined
SH 34.0	1mm	On request only	31.0 mm	1mm	1101321
SH 35.5	2mm	1088010	33.0 mm	2mm	ID to be defined
SH 35.5	1mm	On request only	33.0 mm	1mm	On request only
SH 37.0	2mm	1092598	34.0 mm	2mm	1082545
SH 37.0	1mm	On request only	34.0 mm	1mm	On request only
SH 39.0	2mm	ID to be defined	36.0 mm	2mm	ID to be defined
SH 40.5	2mm	ID to be defined	38.0 mm	2mm	ID to be defined
SH 43.0	2mm	ID to be defined	40.0 mm	2mm	ID to be defined
SH 46.0	2mm	1086646	43.0 mm	2mm	1082546
SH 49.0	2mm	1086647	46.0 mm	2mm	ID to be defined

Custom sizes are available on request.

Example: IF BP 575-170 HT SH 25.5 2

Custom sizes are available on request.

Example: IFG BP 575-170 HT 23.0 2

Bandpass 590-50 HT

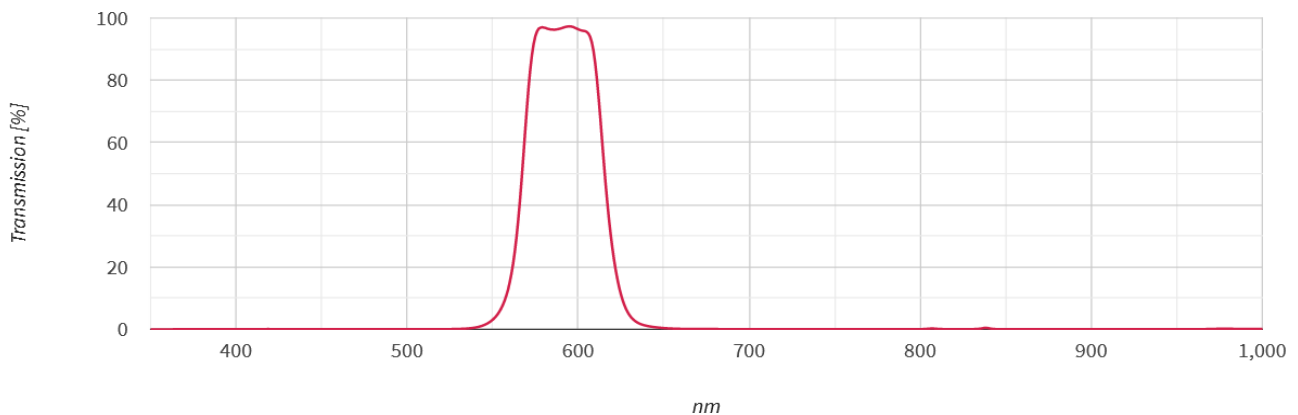

Technical specifications	according to ISO 10110
Angle of incident	0° +/- 8°
Cut-on wavelength	565 +/- 6 nm
Cut-off wavelength	615 +/- 6 nm
Transmittance	585 - 595 nm: T _{abs} > 90%
Blocking	< 530 nm: T _{abs} < 0.5%
	650 - 1000 nm: T _{abs} < 1.0%
Parallelism	1'
Wavefront distortion	Ø >18 - 30 mm: 13/ 1(0.25)
	Ø >30 - 50 mm: 13/ 1(0.30)
Glass Thickness	1.0 +/- 0.08mm
	2.0 +/- 0.08mm

Mounted Filter			Unmounted Filterglass		
IF BP 590-50 HT <i>Mount Thickness</i>			IFG BP 590-50 HT <i>Diameter thickness</i>		
Mount	Thickness	ID	Diameter	Thickness	ID
CMT	2mm	1084480	22.0 mm	2mm	<i>ID to be defined</i>
CMT	1mm	<i>ID to be defined</i>	22.0 mm	1mm	<i>ID to be defined</i>
SH 25.5	2mm	1089732	23.0 mm	2mm	<i>ID to be defined</i>
SH 25.5	1mm	<i>On request only</i>	23.0 mm	1mm	<i>On request only</i>
SH 27.0	2mm	1088593	24.0 mm	2mm	<i>ID to be defined</i>
SH 27.0	1mm	<i>On request only</i>	24.0 mm	1mm	<i>On request only</i>
SN1 30.5	2mm	1085648	29.0 mm	2mm	<i>ID to be defined</i>
SN1 30.5	1mm	<i>On request only</i>	29.0 mm	1mm	<i>On request only</i>
SH 34.0	2mm	<i>ID to be defined</i>	31.0 mm	2mm	<i>ID to be defined</i>
SH 34.0	1mm	<i>On request only</i>	31.0 mm	1mm	<i>On request only</i>
SH 35.5	2mm	1092944	33.0 mm	2mm	<i>ID to be defined</i>
SH 35.5	1mm	<i>On request only</i>	33.0 mm	1mm	<i>On request only</i>
SH 37.0	2mm	<i>ID to be defined</i>	34.0 mm	2mm	1082579
SH 37.0	1mm	<i>On request only</i>	34.0 mm	1mm	<i>ID to be defined</i>
SH 39.0	2mm	<i>ID to be defined</i>	36.0 mm	2mm	<i>ID to be defined</i>
SH 40.5	2mm	1087907	38.0 mm	2mm	<i>ID to be defined</i>
SH 43.0	2mm	1085531	40.0 mm	2mm	<i>ID to be defined</i>
SH 46.0	2mm	1086648	43.0 mm	2mm	1082580
SH 49.0	2mm	<i>ID to be defined</i>	46.0 mm	2mm	<i>ID to be defined</i>

Custom sizes are available on request.

Example: IF BP 590-50 HT SH 25.5 2

Custom sizes are available on request.

Example: IFG BP 590-50 HT 23.0 2

Bandpass 590-200 HT - on request

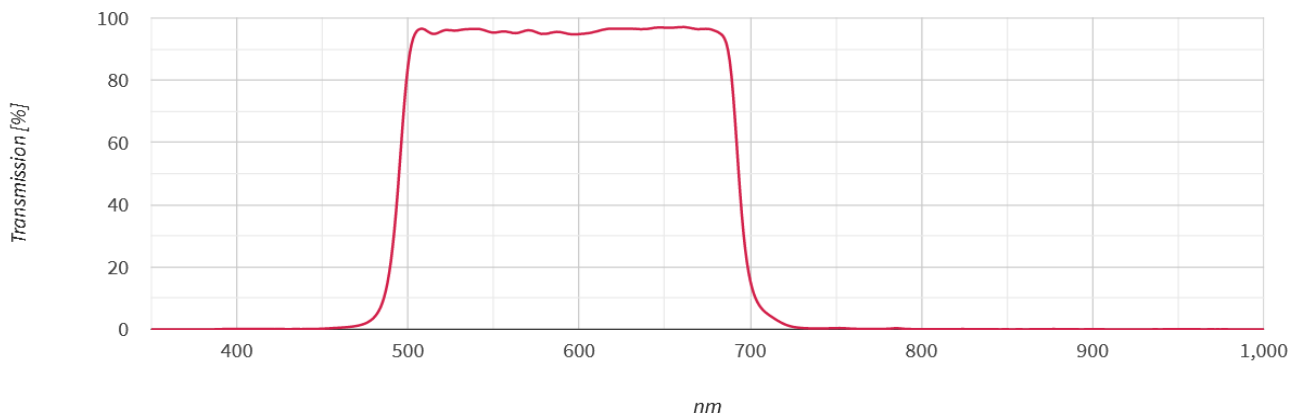

Technical specifications	according to ISO 10110
Angle of incident	0° +/- 8°
Cut-on wavelength	495 +/- 5 nm
Cut-off wavelength	690 +/- 7 nm
Transmittance	515 - 670 nm: $T_{abs} > 90\%$
Blocking	< 450 nm: $T_{abs} < 0.5\%$
	735 - 1100 nm: $T_{abs} < 1.0\%$
Parallelism	1'
Wavefront distortion	Ø >18 - 30 mm: 13/ 1(0.25)
	Ø >30 - 50 mm: 13/ 1(0.30)

Bandpass 635-50 HT

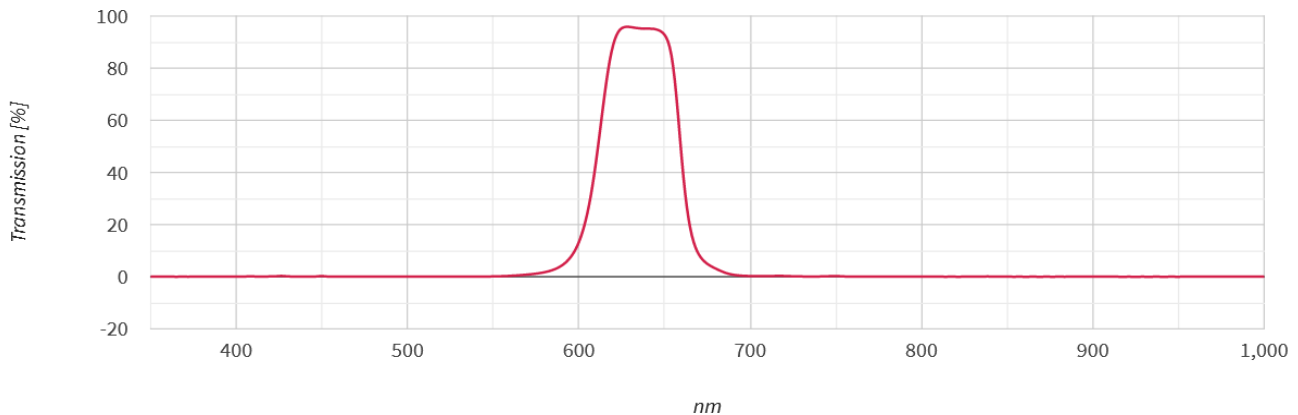

Technical specifications	according to ISO 10110
Angle of incident	0° +/- 8°
Cut-on wavelength	610 +/- 6 nm
Cut-off wavelength	660 +/- 7 nm
Transmittance	630 - 640 nm: T _{abs} > 90%
Blocking	< 550 nm: T _{abs} < 0.5%
	710 - 1050 nm: T _{abs} < 1.0%
Parallelism	1'
Wavefront distortion	Ø >18 - 30 mm: 13/ 1(0.25)
	Ø >30 - 50 mm: 13/ 1(0.30)
Glass Thickness	1.0 +/- 0.08mm
	2.0 +/- 0.08mm

Mounted Filter			Unmounted Filterglass		
IF BP 635-50 HT <i>Mount Thickness</i>			IFG BP 635-50 HT <i>Diameter thickness</i>		
Mount	Thickness	ID	Diameter	Thickness	ID
CMT	2mm	1085680	22.0 mm	2mm	1095000
CMT	1mm	1101098	22.0 mm	1mm	ID to be defined
SH 25.5	2mm	1084445	23.0 mm	2mm	ID to be defined
SH 25.5	1mm	On request only	23.0 mm	1mm	On request only
SH 27.0	2mm	1084641	24.0 mm	2mm	ID to be defined
SH 27.0	1mm	On request only	24.0 mm	1mm	On request only
SN1 30.5	2mm	1085091	29.0 mm	2mm	ID to be defined
SN1 30.5	1mm	On request only	29.0 mm	1mm	On request only
SH 34.0	2mm	ID to be defined	31.0 mm	2mm	ID to be defined
SH 34.0	1mm	On request only	31.0 mm	1mm	On request only
SH 35.5	2mm	1085185	33.0 mm	2mm	ID to be defined
SH 35.5	1mm	On request only	33.0 mm	1mm	On request only
SH 37.0	2mm	1085816	34.0 mm	2mm	1082535
SH 37.0	1mm	On request only	34.0 mm	1mm	1101097
SH 39.0	2mm	ID to be defined	36.0 mm	2mm	ID to be defined
SH 40.5	2mm	1084423	38.0 mm	2mm	ID to be defined
SH 43.0	2mm	1083606	40.0 mm	2mm	1097122
SH 46.0	2mm	1086649	43.0 mm	2mm	1082536
SH 49.0	2mm	1090632	46.0 mm	2mm	ID to be defined

Custom sizes are available on request.

Example: IF BP 635-50 HT SH 25.5 2

Custom sizes are available on request.

Example: IFG BP 635-50 HT 23.0 2

Bandpass 640-100 HT - on request

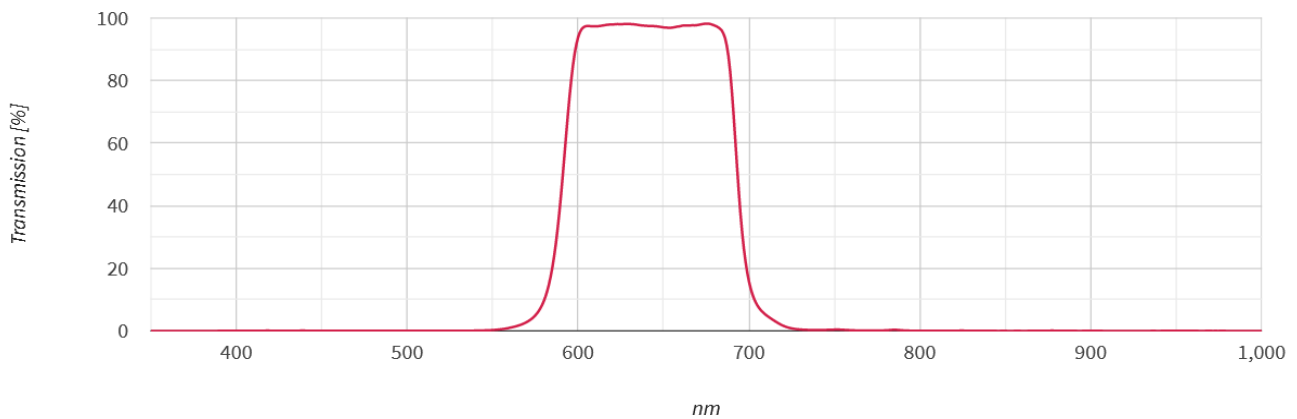

Technical specifications	according to ISO 10110
Angle of incident	0° +/- 8°
Cut-on wavelength	590 +/- 6 nm
Cut-off wavelength	690 +/- 7 nm
Transmittance	630 - 640 nm: $T_{abs} > 90\%$ < 550 nm: $T_{abs} < 0.5\%$
Blocking	710 - 1050 nm: $T_{abs} < 1.0\%$
Parallelism	1'
Wavefront distortion	Ø >18 - 30 mm: 13/ 1(0.25) Ø >30 - 50 mm: 13/ 1(0.30)

Bandpass 660-60 HT

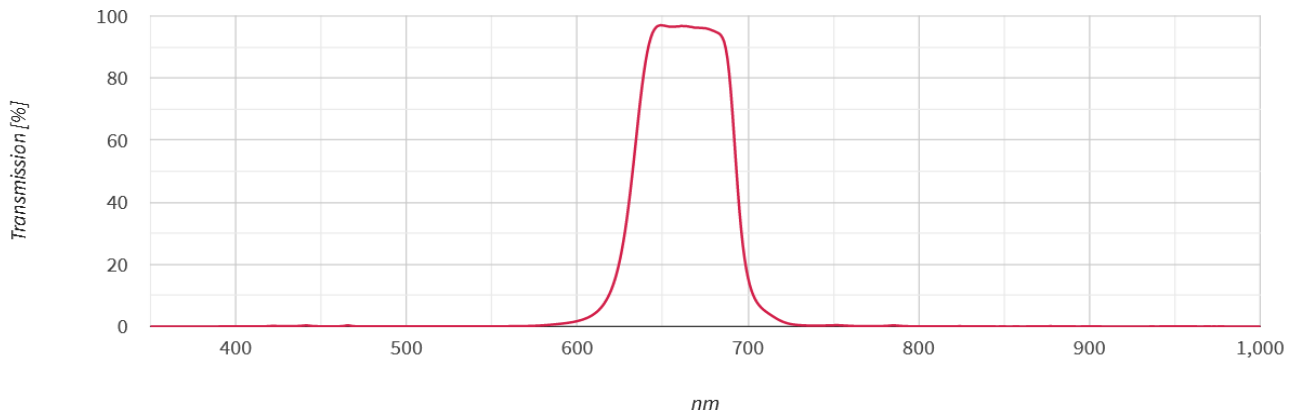

Technical specifications	according to ISO 10110
Angle of incident	0° +/- 8°
Cut-on wavelength	630 +/- 6 nm
Cut-off wavelength	690 +/- 7 nm
Transmittance	640 - 670 nm: T _{abs} > 90%
Blocking	< 570 nm: T _{abs} < 0.5%
	735 - 1100 nm: T _{abs} < 1.0%
Parallelism	1'
Wavefront distortion	Ø >18 - 30 mm: 13/ 1(0.25)
	Ø >30 - 50 mm: 13/ 1(0.30)
Glass Thickness	1.0 +/- 0.08mm
	2.0 +/- 0.08mm

Mounted Filter			Unmounted Filterglass		
IF BP 660-60 HT <i>Mount Thickness</i>			IFG BP 660-60 HT <i>Diameter thickness</i>		
Mount	Thickness	ID	Diameter	Thickness	ID
CMT	2mm	1085682	22.0 mm	2mm	1091132
CMT	1mm	<i>ID to be defined</i>	22.0 mm	1mm	<i>On request only</i>
SH 25.5	2mm	1085714	23.0 mm	2mm	<i>ID to be defined</i>
SH 25.5	1mm	<i>On request only</i>	23.0 mm	1mm	<i>On request only</i>
SH 27.0	2mm	1084557	24.0 mm	2mm	<i>ID to be defined</i>
SH 27.0	1mm	<i>On request only</i>	24.0 mm	1mm	<i>On request only</i>
SN1 30.5	2mm	1084481	29.0 mm	2mm	<i>ID to be defined</i>
SN1 30.5	1mm	<i>On request only</i>	29.0 mm	1mm	<i>On request only</i>
SH 34.0	2mm	<i>ID to be defined</i>	31.0 mm	2mm	<i>ID to be defined</i>
SH 34.0	1mm	<i>On request only</i>	31.0 mm	1mm	<i>On request only</i>
SH 35.5	2mm	1085325	33.0 mm	2mm	<i>ID to be defined</i>
SH 35.5	1mm	<i>On request only</i>	33.0 mm	1mm	<i>On request only</i>
SH 37.0	2mm	1085386	34.0 mm	2mm	1082519
SH 37.0	1mm	<i>On request only</i>	34.0 mm	1mm	<i>ID to be defined</i>
SH 39.0	2mm	<i>ID to be defined</i>	36.0 mm	2mm	<i>ID to be defined</i>
SH 40.5	2mm	1085715	38.0 mm	2mm	<i>ID to be defined</i>
SH 43.0	2mm	1085716	40.0 mm	2mm	<i>ID to be defined</i>
SH 46.0	2mm	1086651	43.0 mm	2mm	1082520
SH 49.0	2mm	1085387	46.0 mm	2mm	1088164

Custom sizes are available on request.

Example: IF BP 660-60 HT SH 25.5 2

Custom sizes are available on request.

Example: IFG BP 660-60 HT 23.0 2

Bandpass 680-100 HT - on request

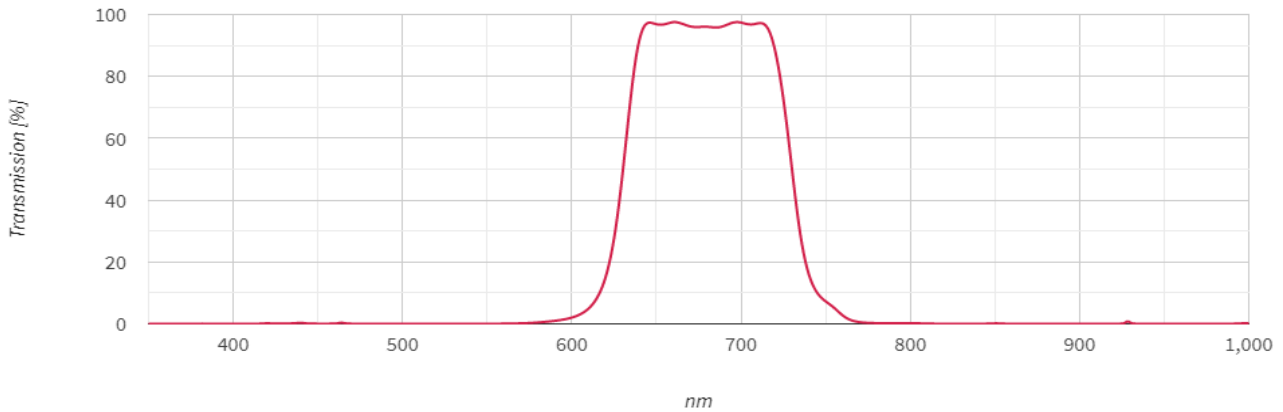

Technical specifications	according to ISO 10110
Angle of incident	0° +/- 8°
Cut-on wavelength	630 +/- 6 nm
Cut-off wavelength	730 +/- 7 nm
Transmittance	650 - 710 nm: $T_{abs} > 90\%$
Blocking	< 570 nm: $T_{abs} < 0.5\%$
	780 - 1100 nm: $T_{abs} < 1.0\%$
Parallelism	1'
Wavefront distortion	Ø >18 - 30 mm: 13/ 1(0.25)
	Ø >30 - 50 mm: 13/ 1(0.30)

Bandpass 850-80 HT

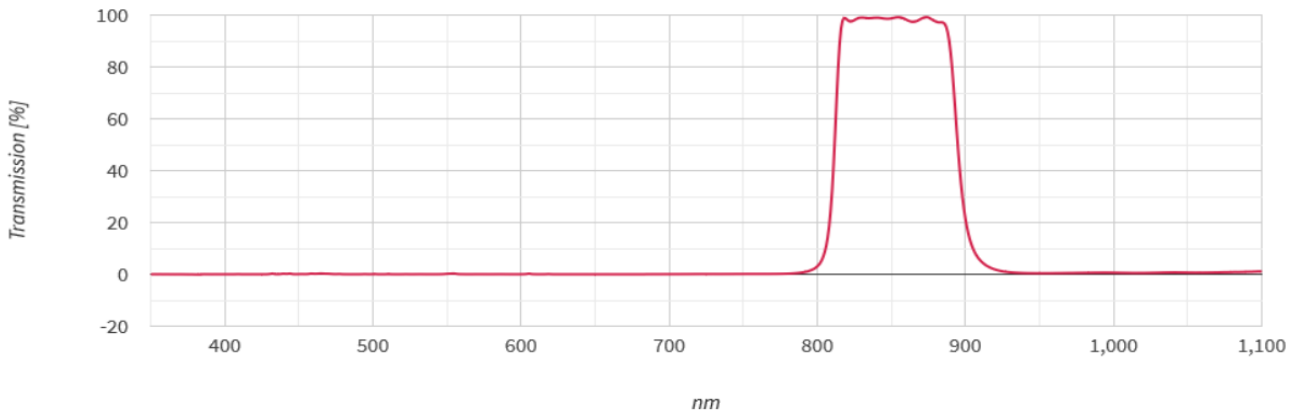

Technical specifications	according to ISO 10110
Angle of incident	0° +/- 8°
Cut-on wavelength	810 +/- 8 nm
Cut-off wavelength	890 +/- 9 nm
Transmittance	825 - 875 nm: T _{abs} > 90%
Blocking	< 775 nm: T _{abs} < 0.5%
	930 - 1100 nm: T _{abs} < 1.0%
Parallelism	1'
Wavefront distortion	Ø >18 - 30 mm: 13/ 1(0.25)
	Ø >30 - 50 mm: 13/ 1(0.30)
Glass Thickness	1.0 +/- 0.08mm
	2.0 +/- 0.08mm

Mounted Filter			Unmounted Filterglass		
IF BP 850-80 HT <i>Mount Thickness</i>			IFG BP 850-80 HT <i>Diameter thickness</i>		
Mount	Thickness	ID	Diameter	Thickness	ID
CMT	2mm	ID to be defined	22.0 mm	2mm	ID to be defined
CMT	1mm	1099928	22.0 mm	1mm	1100033
SH 25.5	2mm	1102629	23.0 mm	2mm	ID to be defined
SH 25.5	1mm	On request only	23.0 mm	1mm	On request only
SH 27.0	2mm	ID to be defined	24.0 mm	2mm	ID to be defined
SH 27.0	1mm	On request only	24.0 mm	1mm	On request only
SN1 30.5	2mm	1099929	29.0 mm	2mm	ID to be defined
SN1 30.5	1mm	On request only	29.0 mm	1mm	On request only
SH 34.0	2mm	ID to be defined	31.0 mm	2mm	ID to be defined
SH 34.0	1mm	On request only	31.0 mm	1mm	On request only
SH 35.5	2mm	ID to be defined	33.0 mm	2mm	ID to be defined
SH 35.5	1mm	On request only	33.0 mm	1mm	On request only
SH 37.0	2mm	ID to be defined	34.0 mm	2mm	1100029
SH 37.0	1mm	On request only	34.0 mm	1mm	1100034
SH 39.0	2mm	ID to be defined	36.0 mm	2mm	ID to be defined
SH 40.5	2mm	ID to be defined	38.0 mm	2mm	ID to be defined
SH 43.0	2mm	ID to be defined	40.0 mm	2mm	ID to be defined
SH 46.0	2mm	ID to be defined	43.0 mm	2mm	1100030
SH 49.0	2mm	ID to be defined	46.0 mm	2mm	ID to be defined

Custom sizes are available on request.

Example: IF BP 850-80 HT SH 25.5 2

Custom sizes are available on request.

Example: IFG BP 850-80 HT 23.0 2

Bandpass 865-100 HT

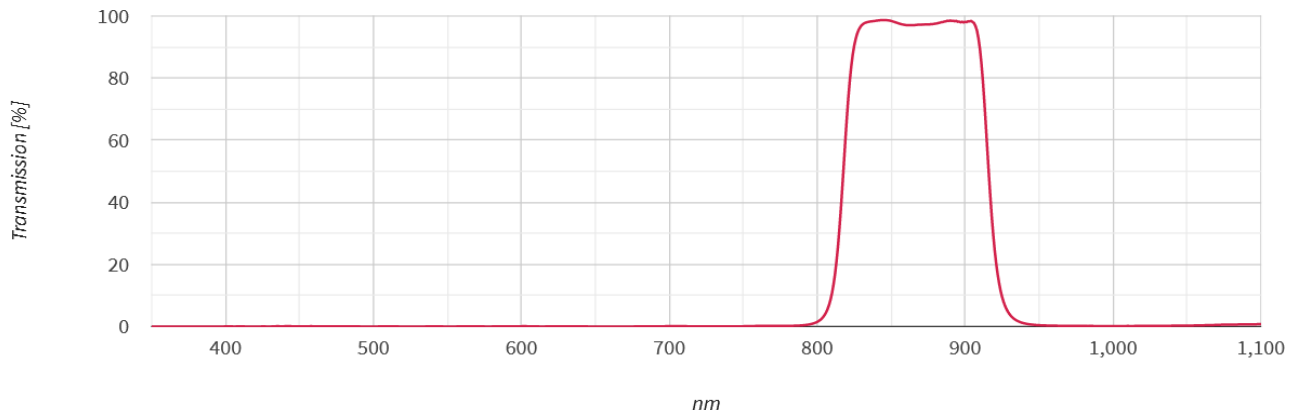

Technical specifications	according to ISO 10110
Angle of incident	0° +/- 8°
Cut-on wavelength	815 +/- 8 nm
Cut-off wavelength	915 +/- 9 nm
Transmittance	840 - 890 nm: T _{abs} > 90%
Blocking	< 780 nm: T _{abs} < 0.5%
	950 - 1100 nm: T _{abs} < 1.0%
Parallelism	1'
Wavefront distortion	Ø >18 - 30 mm: 13/ 1(0.25)
	Ø >30 - 50 mm: 13/ 1(0.30)
Glass Thickness	1.0 +/- 0.08mm
	2.0 +/- 0.08mm

Mounted Filter			Unmounted Filterglass		
IF BP 865-100 HT <i>Mount Thickness</i>			IFG BP 865-100 HT <i>Diameter thickness</i>		
Mount	Thickness	ID	Diameter	Thickness	ID
CMT	2mm	1085684	22.0 mm	2mm	<i>ID to be defined</i>
CMT	1mm	<i>ID to be defined</i>	22.0 mm	1mm	<i>ID to be defined</i>
SH 25.5	2mm	1085691	23.0 mm	2mm	<i>ID to be defined</i>
SH 25.5	1mm	<i>On request only</i>	23.0 mm	1mm	<i>On request only</i>
SH 27.0	2mm	1085692	24.0 mm	2mm	<i>ID to be defined</i>
SH 27.0	1mm	<i>On request only</i>	24.0 mm	1mm	<i>On request only</i>
SN1 30.5	2mm	1084556	29.0 mm	2mm	<i>ID to be defined</i>
SN1 30.5	1mm	<i>On request only</i>	29.0 mm	1mm	<i>On request only</i>
SH 34.0	2mm	<i>ID to be defined</i>	31.0 mm	2mm	<i>ID to be defined</i>
SH 34.0	1mm	<i>On request only</i>	31.0 mm	1mm	<i>On request only</i>
SH 35.5	2mm	1088308	33.0 mm	2mm	<i>ID to be defined</i>
SH 35.5	1mm	<i>On request only</i>	33.0 mm	1mm	<i>On request only</i>
SH 37.0	2mm	1088391	34.0 mm	2mm	1082470
SH 37.0	1mm	<i>On request only</i>	34.0 mm	1mm	1100484
SH 39.0	2mm	1088392	36.0 mm	2mm	<i>ID to be defined</i>
SH 40.5	2mm	1085693	38.0 mm	2mm	<i>ID to be defined</i>
SH 43.0	2mm	1085695	40.0 mm	2mm	<i>ID to be defined</i>
SH 46.0	2mm	1086653	43.0 mm	2mm	1082471
SH 49.0	2mm	1088448	46.0 mm	2mm	<i>ID to be defined</i>

Custom sizes are available on request.

Example: *IF BP 865-100 HT SH 25.5 2*

Custom sizes are available on request.

Example: *IFG BP 865-100 HT 23.0 2*

C-Mount

Defined by 1" (25.4mm) diameter and 32 turns per inch pitch, C-Mount thread is a popular camera mount in machine vision industry. Schneider-Kreuznach offers for most filters a CMT mount option. So that filters can go in any C-Mount based mechanics in vision systems. Another popular application, CMT mounts can easily be used for, is placing a filter in front of the sensor into the camera. The extension of the back flange distance has to be considered for imaging applications.

Key features	Applications
--------------	--------------

- Fits in C-Mount cameras
- Black Anodized Brass
- To be mounted in C-Mount cameras
- Vision Systems based on C-Mount mechanics

Thread	Diameter	Clear Aperture	Thickness
1" - 32	25.4 mm	21.1 mm	3.6 mm

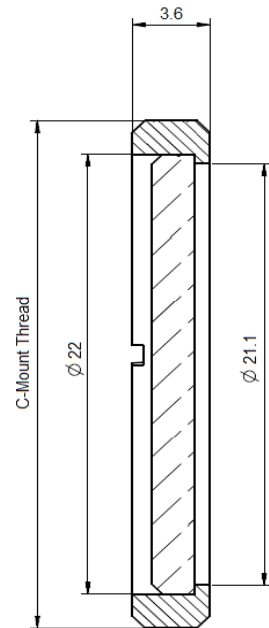

SH-Mount

Schneider-Kreuznach offers a variety of mounts with common thread sizes to fit on most camera lens systems. SH-Mount is the standard, when high flexibility is needed. Filters are held by retainer rings. SH-Mounts are extreme robust. All SH-Mounts have a female and male M-thread, and can be stacked if several filters must be combined.

Key features	Applications
--------------	--------------

- Stackable
- Robust
- Black Anodized Brass
- Mounted on lenses in imaging applications
- Mounted on measurement instruments

Thread	Diameter	Clear Aperture	Thickness
M 25.5x0.5	29.5 mm	20.8mm	6.4 mm
M 27.0x0.5	31.0 mm	21.8 mm	6.4 mm
M 35.5x0.5	39.5 mm	29.8 mm	6.4 mm
M 37.0x0.75	41.0 mm	31.8 mm	6.9 mm
M 39.0x0.5	43.0 mm	33.8 mm	6.4 mm
M 40.5x0.5	44.5 mm	35.8 mm	6.4 mm
M 43.0x0.75	47.0 mm	37.8 mm	6.9 mm
M 46.0x0.75	50.0 mm	40.8 mm	6.9 mm
M 49.0x0.75	53.0 mm	43.8 mm	6.9 mm
M 52.0x0.75	56.0 mm	46.8 mm	6.9 mm
M 55.0x0.75	59.0 mm	49.8 mm	6.9 mm
M 58.0x0.75	62.0 mm	52.8 mm	6.9 mm
M 62.0x0.75	66.0 mm	56.8 mm	6.9 mm
M 67.0x0.75	71.0 mm	61.8 mm	6.9 mm

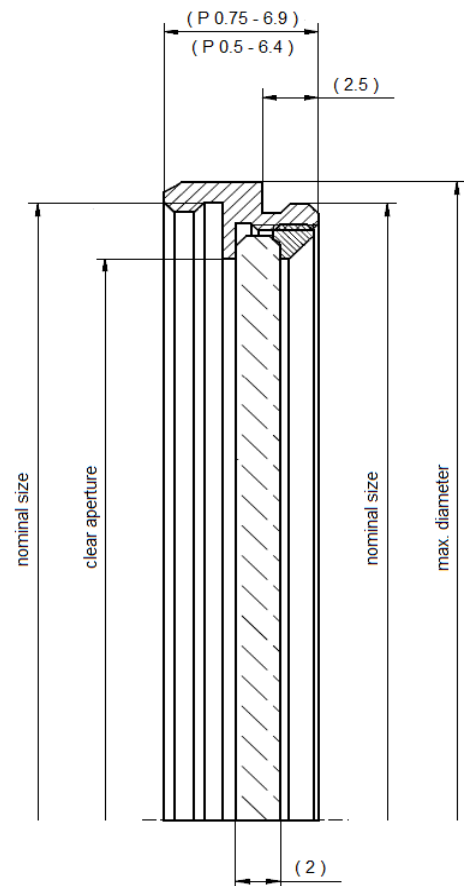

SN1-Mount

SN1-Mount was designed for in machine vision industry popular M30.5x0.5 thread. With its high clear aperture, vignetting can be avoided, even for wide angle applications. The filter is glued into the mount, in order to secure it against vibrations when integrated into robots or production lines. It is ideal to be used in automated fabrication.

SN1-Mounts have a male and female M-thread, and can be stacked if several filters must be combined.

Key features	Applications
--------------	--------------

- | | |
|--|---|
| <ul style="list-style-type: none"> • Maximum Clear Aperture • No vignetting • Stackable • Robust • Black Anodized Brass | <ul style="list-style-type: none"> • Mounted on lenses in imaging applications • Mounted on measurement instruments |
|--|---|

Thread	Diameter	Clear Aperture	Thickness
M 30.5x0.5	32 mm	28 mm	6.5 mm

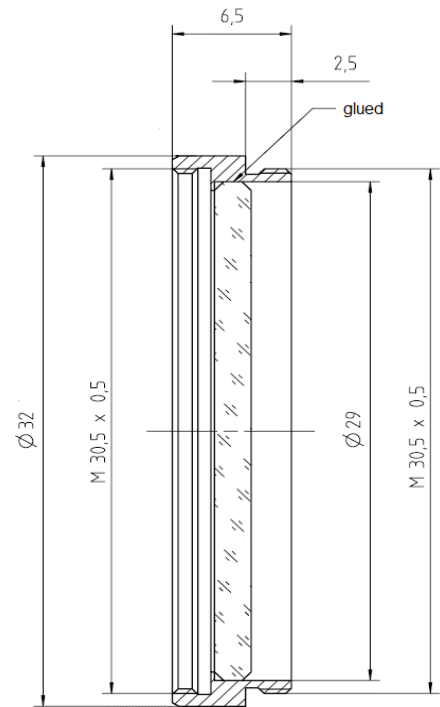

SN2-Mount

The SN2-Mount is designed for polarizers and achieves highest possible aperture, avoiding vignetting in machine vision systems. Its unique locking mechanism fixes the correct orientation, even in typical industrial environment. The filters are glued into the mount to secure them against vibrations when integrated into robots or production lines. Ideal to be used in automated fabrication.

SN2-Mounts have a female and male M-thread, and can be stacked if several filters must be combined.

Key features	Applications
--------------	--------------

- | | |
|--|---|
| <ul style="list-style-type: none"> • Rotatable • High clear Aperture • No vignetting • Stackable • Robust • Black Anodized Brass | <ul style="list-style-type: none"> • Mounted on lenses in imaging applications • Mounted on measurement instruments |
|--|---|

Thread	Diameter	Clear Aperture	Thickness
M 25.5x0.5	27 mm	22.7 mm	7.4 mm
M 27.0x0.5	28.5 mm	23.7 mm	7.4 mm
M 30.5x0.5	32 mm	26.7 mm	7.4 mm
M 35.5 x0.5	37 mm	31.7 mm	7.4 mm
M 37.0x0.75	38.5 mm	32.7 mm	7.4 mm
M 40.5x0.5	42 mm	36.7 mm	7.4 mm
M 43.0x0.75	44.5 mm	37.7 mm	7.4 mm
M 46.0x0.75	47.5 mm	41.7 mm	7.4 mm
M 49.0x0.75	50.5 mm	44.7 mm	7.4 mm

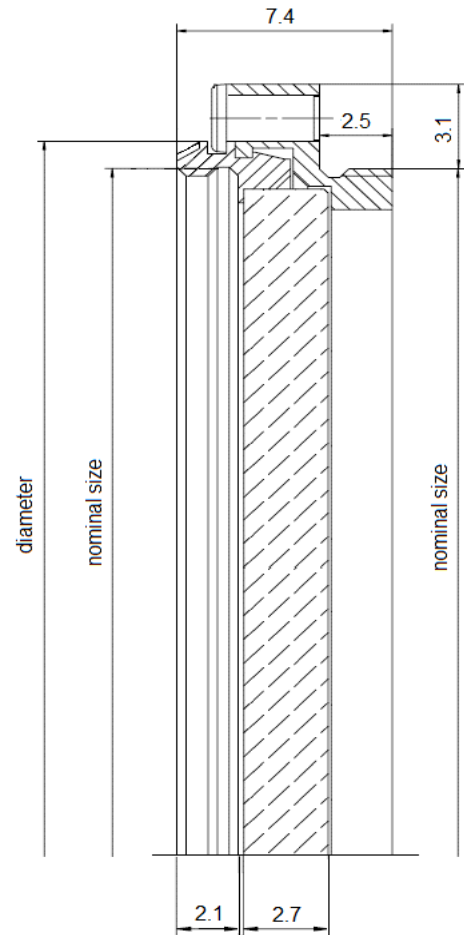

DH-Mount

Schneider-Kreuznach offers a variety of mounts for polarizers with common thread sizes to fit on most camera lens systems. The DH-Mount is rotatable to adjust polarization axis in the required orientation. Filters are held by retainer rings.

All DH-Mounts have a female and male M-thread and can be stacked if several filters must be combined.

Key features	Applications
--------------	--------------

- Rotatable
- Stackable
- Black Anodized Brass
- Mounted on lenses in imaging applications
- Mounted on measurement instruments

Thread	Diameter	Clear Aperture	Thickness
M 25.5x0.5	27 mm	20.8 mm	9.2 mm
M 27.0x0.5	28.5 mm	21.8 mm	9.2 mm
M 30.5x0.5	32 mm	25.8 mm	9.2 mm
M 35.5x0.5	37 mm	30.8 mm	9.2 mm
M 37.0x0.75	38.5 mm	31.8 mm	9.2 mm
M 40.5x0.5	42 mm	35.8 mm	9.2 mm
M 43.0x0.75	44.5 mm	37.8 mm	9.2 mm
M 46.0x0.75	47.5 mm	40.8 mm	9.2 mm
M 49.0x0.75	50.5 mm	43.8 mm	9.2 mm
M 52.0x0.75	53.5 mm	46.8 mm	9.2 mm
M 55.0x0.75	56.5 mm	49.8 mm	9.2 mm
M 58.0x0.75	59.5 mm	52.8 mm	9.2 mm
M 62.0x0.75	63.5 mm	56.8 mm	9.2 mm
M 67.0x0.75	68.5 mm	61.8 mm	9.2 mm

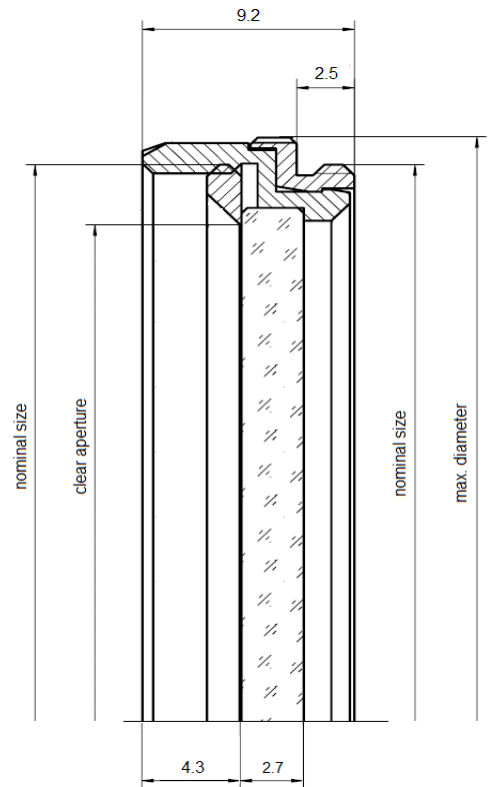

Headquarters Europe

Jos. Schneider Optische Werke GmbH

Ringstraße 132
55543 Bad Kreuznach
+49 671 601 205
cs@schneiderkreuznach.com
www.schneiderkreuznach.com

Offices Worldwide

America

+1 800 645 7239 (East Coast)
+1 800 228 1254 (West Coast)
info@schneideroptics.com

Asia

+86 755 8832 1170
info@schneider-asiapacific.com